



North Washington Street Bridge Project

Boston, Massachusetts

25% Preliminary Design Public Hearing

December 16, 2015



City of Boston: Para Jayasinghe, City Engineer

Mass DOT: Michael O'Dowd, Project Manager



Project Team

City of Boston
Mass DOT Highway Division
Federal Highway Administration



Bridge Engineer: Benesch
Bridge Architect: Rosales + Partners
Public Involvement Specialist: Howard Stein Hudson





Existing Bridge

CHARLESTOWN

BOSTON HARBOR

NORTH END

NORTH WASHINGTON STREET BRIDGE

LOVEJOY WHARF

ZAKIM BRIDGE

Existing Bridge Context

CHARLES RIVER

Project Limits

Project Limits

NORTH END

CHARLESTOWN

BOSTON HARBOR

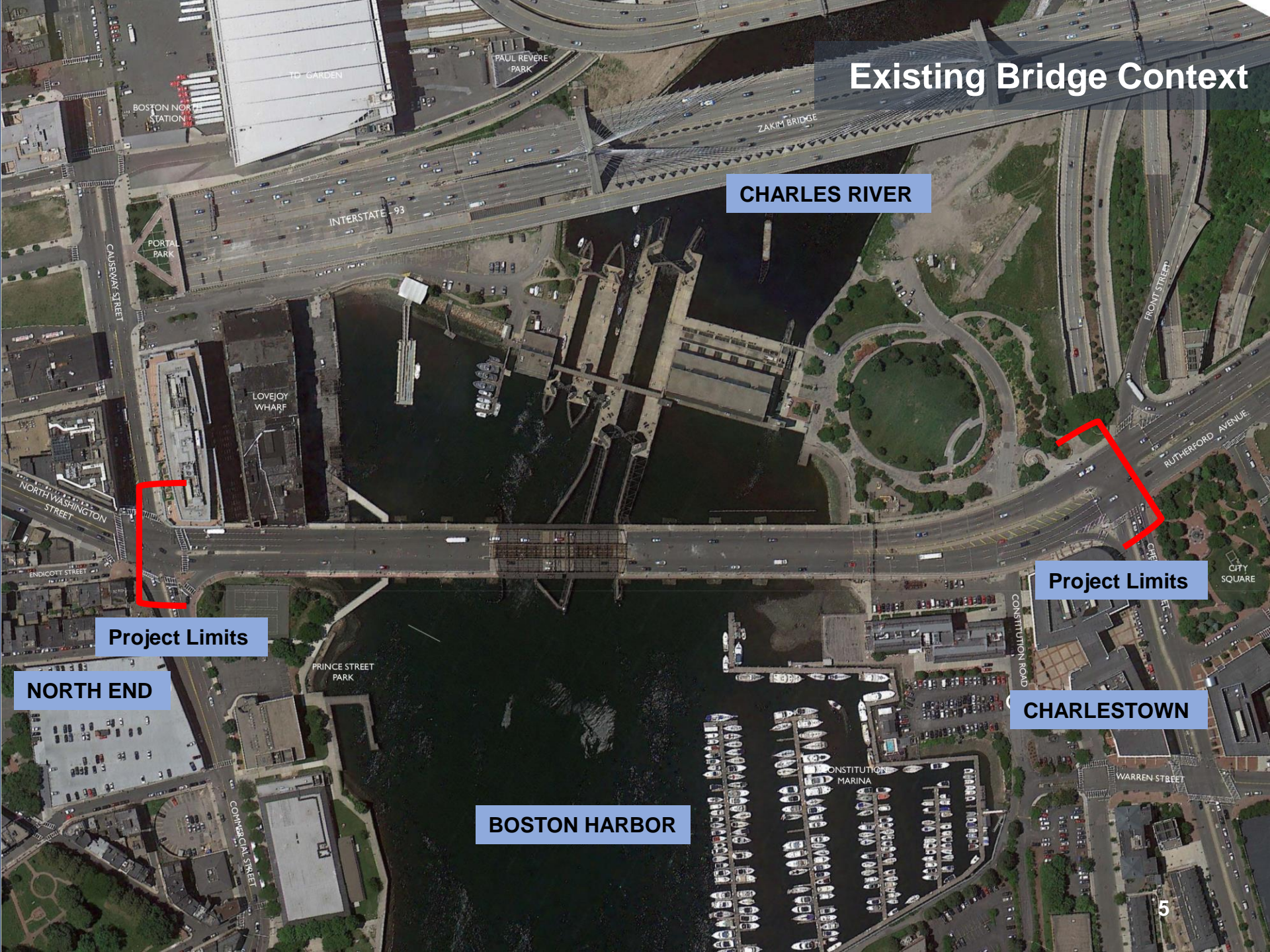

BOSTON NORTH STATION

TD GARDEN

PAUL REVERE PARK

ZAKIM BRIDGE

INTERSTATE 93

PORTAL PARK

LOVEJOY WHARF

NORTH WASHINGTON STREET

ENDICOTT STREET

PRINCE STREET PARK

COMMERCIAL STREET

CONSTITUTION MARINA

CONSTITUTION ROAD

WARREN STREET

5

Project History

- 1898 Existing Bridge Constructed - 12 spans, 1087' in Length
- 1956 Bridge is Reconstructed
- 1961 Swing Span Closed Permanently
- 1977 Elevated Street Railway Structure Removed
- 1992 Adjoining Warehouse Bridge Structure in Charlestown is Replaced
- 2003 Center Truss Bay Lanes Closed
- 2004-2015 Ongoing Maintenance and Repairs



Existing Bridge

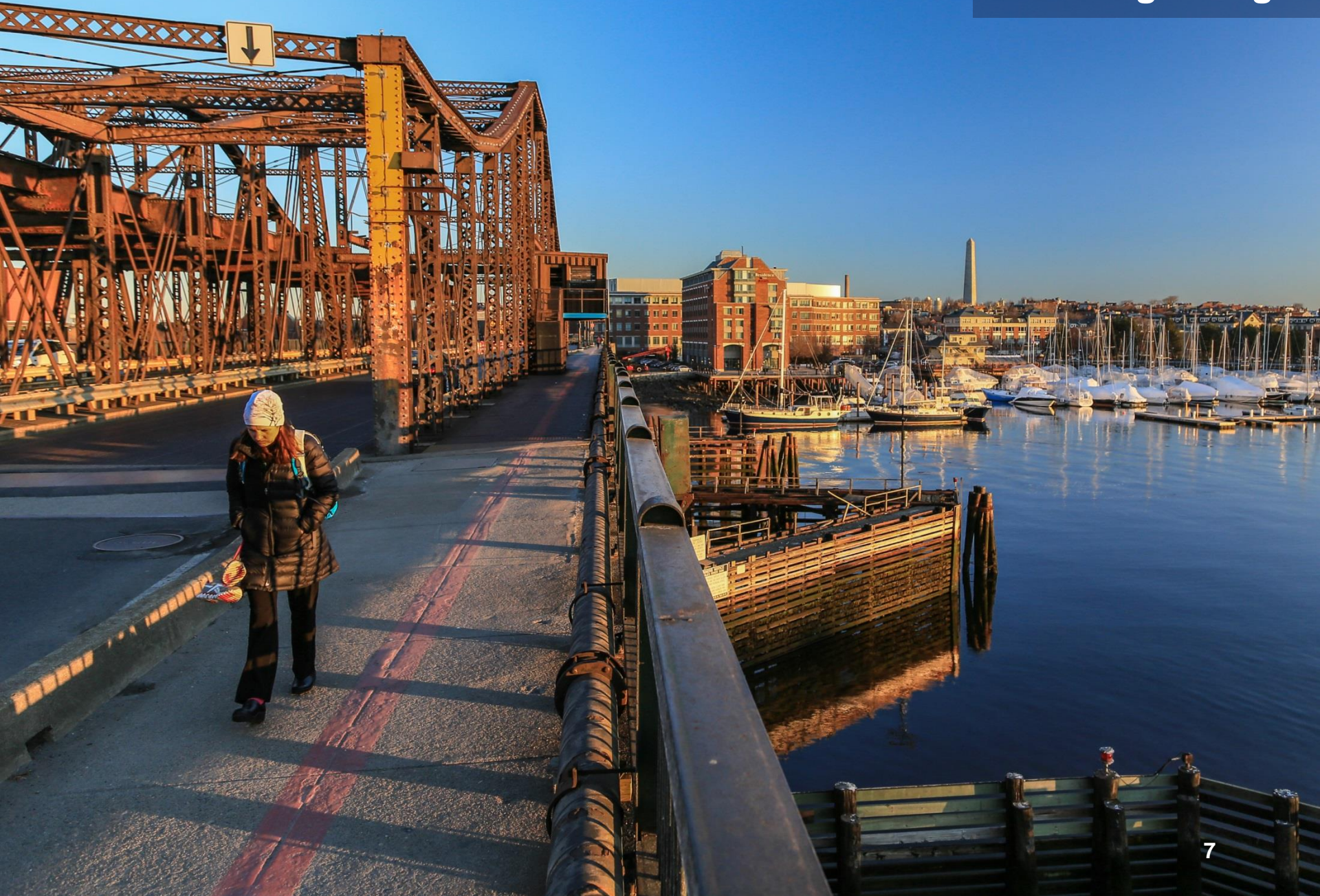

Existing Bridge



Existing Bridge



- Replacement of Structurally Deficient Bridge
- Multi-Modal Bridge as a Complete City Street over Water
- Improvements to Deficient Bike and Pedestrian Accommodations
- Improvements to Intersections Safety and Functionality
- Improvements to Navigation Channel
- Context Sensitive Bridge Design in Important Waterfront and Historic Bridge Location
- Visually Appealing Bridge Design Complementing the Zakim Bridge

Proposed Bridge – Design Philosophy

Form

Iconic
(Zakim Bridge)

vs.

Iconic-lite
(Charlestown Bridge)



Function

Interstate Highway
(Zakim Bridge)

vs.

City Street over water
(Charlestown Bridge)

Bridge Type Study Alternatives



Bridge Type Study Alternatives



Double Steel Arch Alternative



Single Diagonal Steel Arch Alternative



Hammerhead Piers Alternative



V-Shape Piers Alternative

Bridge Type Selection Criteria

- Constructability
- Initial Construction Cost
- Life Cycle Maintenance Cost
- Structural Considerations
- Bridge Aesthetics
- Context Sensitive Considerations
- Environmental / Permitting

History of Public Outreach

- Meeting with DCR and Coast Guard: Spring 2014
- City of Boston Interdepartmental Briefing Including Boston Landmarks Commission: Summer 2014
- Charlestown Neighborhood Community Meeting: Fall of 2014
- North End Neighborhood Community Meeting: Fall of 2014
- Bicycle and Pedestrian Advocacy Groups Meeting Including Walk Boston, Livable Streets, and MassBike: Fall of 2014
- Charlestown Preservation Society: Winter of 2015
- Stakeholders Meetings Include Marriott Hotel, Constitution Marina, and Downtown North Association: Spring of 2015
- A Better City Transportation Committee : Spring of 2015
- Friends of City Square Park: Fall of 2015

Form - Zakim Bridge



Form – Existing Charlestown Bridge



Form - Proposed Bridge Aerial View



Form - Proposed Bridge Elevation View



Function – Zakim Bridge



Function - Proposed Bridge



Context Plan with Proposed Bridge



TD GARDEN

BOSTON NORTH STATION

ZAKIM BRIDGE

CHARLES RIVER

INTERSTATE - 93

PORTAL PARK

CAUSEWAY STREET

LOVEJOY WHARF

PAUL REVERE PARK

FRONT STREET

RUTHERFORD AVENUE

NORTH WASHINGTON STREET

ENDICOTT STREET

CITY SQUARE

Project Limits

NORTH END

PRINCE STREET PARK

CHARLESTOWN

CONSTITUTION ROAD

CONSTITUTION MARINA

WARREN STREET

BOSTON HARBOR

Proposed Bridge Elevation

- Constant Depth Trapezoidal Steel Box Superstructure
- Five Sets of Concrete V Piers Substructure
- Main Span 190 Feet
- Overall Length 1,087 Feet

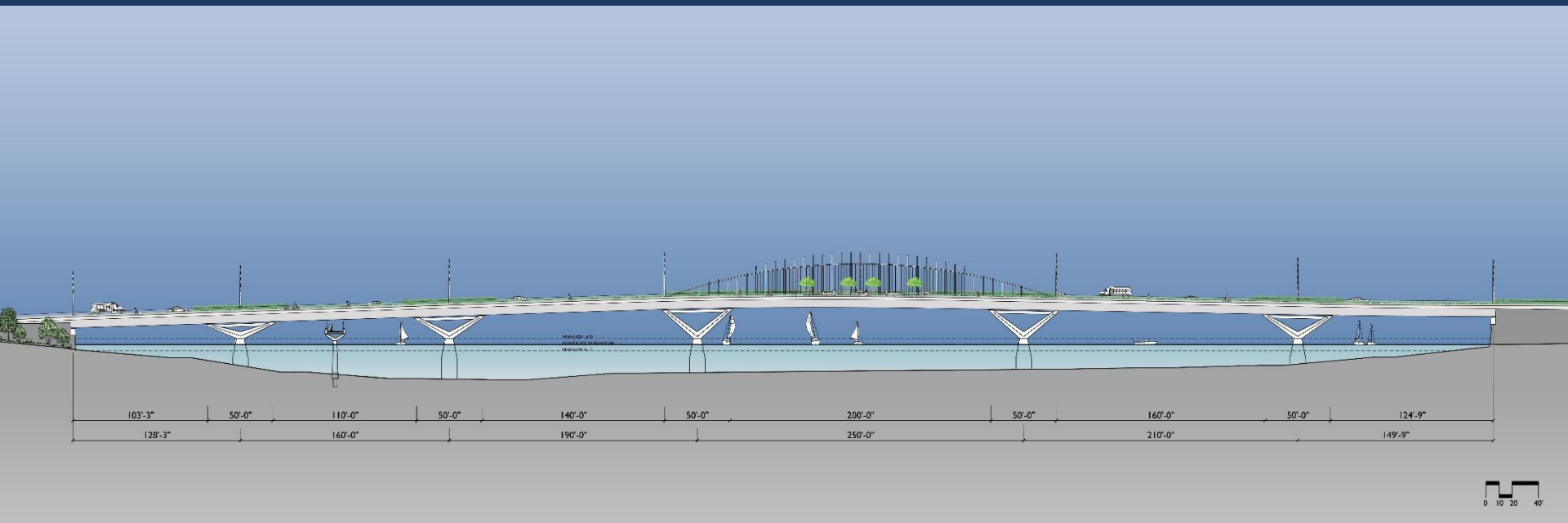

Existing Bridge Cross Section at Approach Spans

- Plate Girder Bridge
- Granite Historic Piers

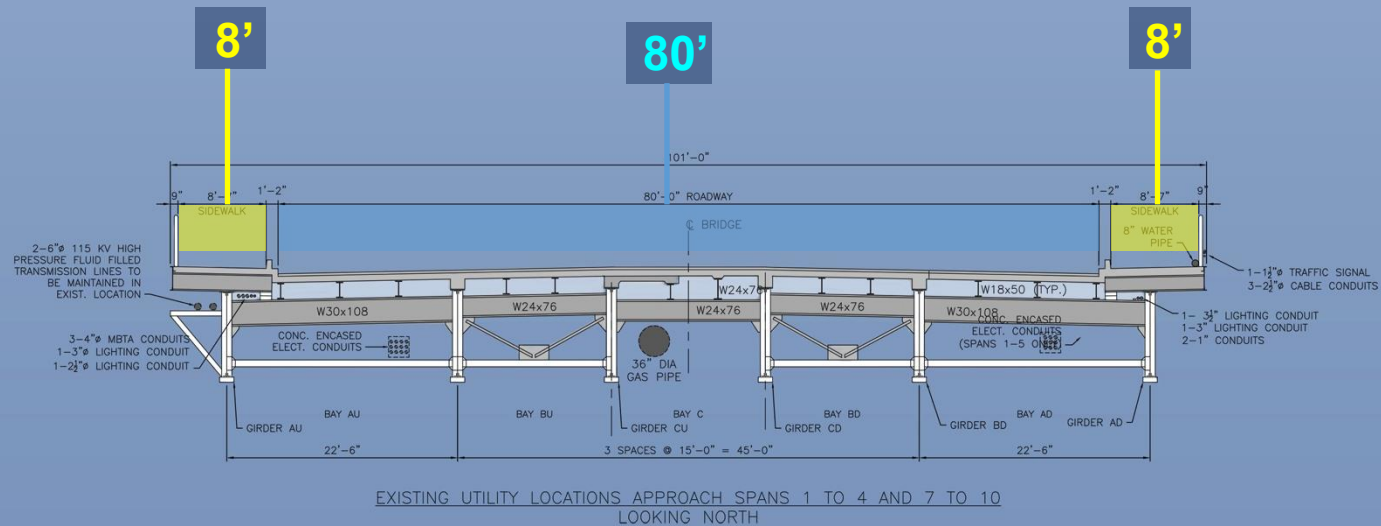

Existing Bridge Cross Section at Navigation Span

- Swing Movable Span
- Steel Truss

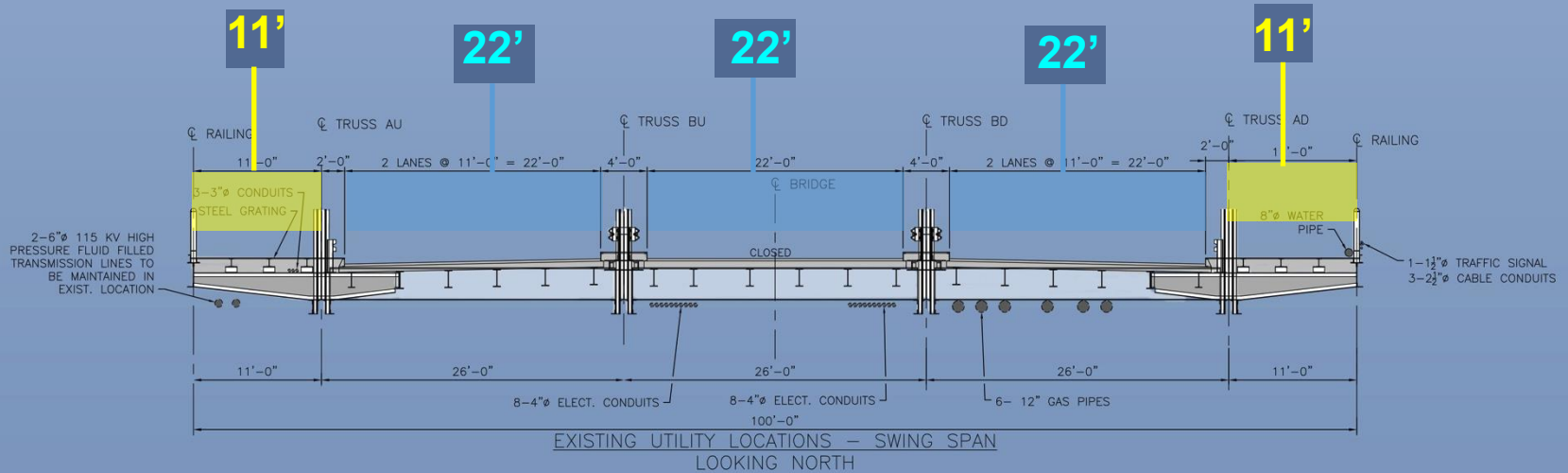

Proposed Bridge Cross Section at Approach Spans

- Wide Sidewalks
- Separated Bike Lanes
- Two Vehicular Lanes in Each Direction

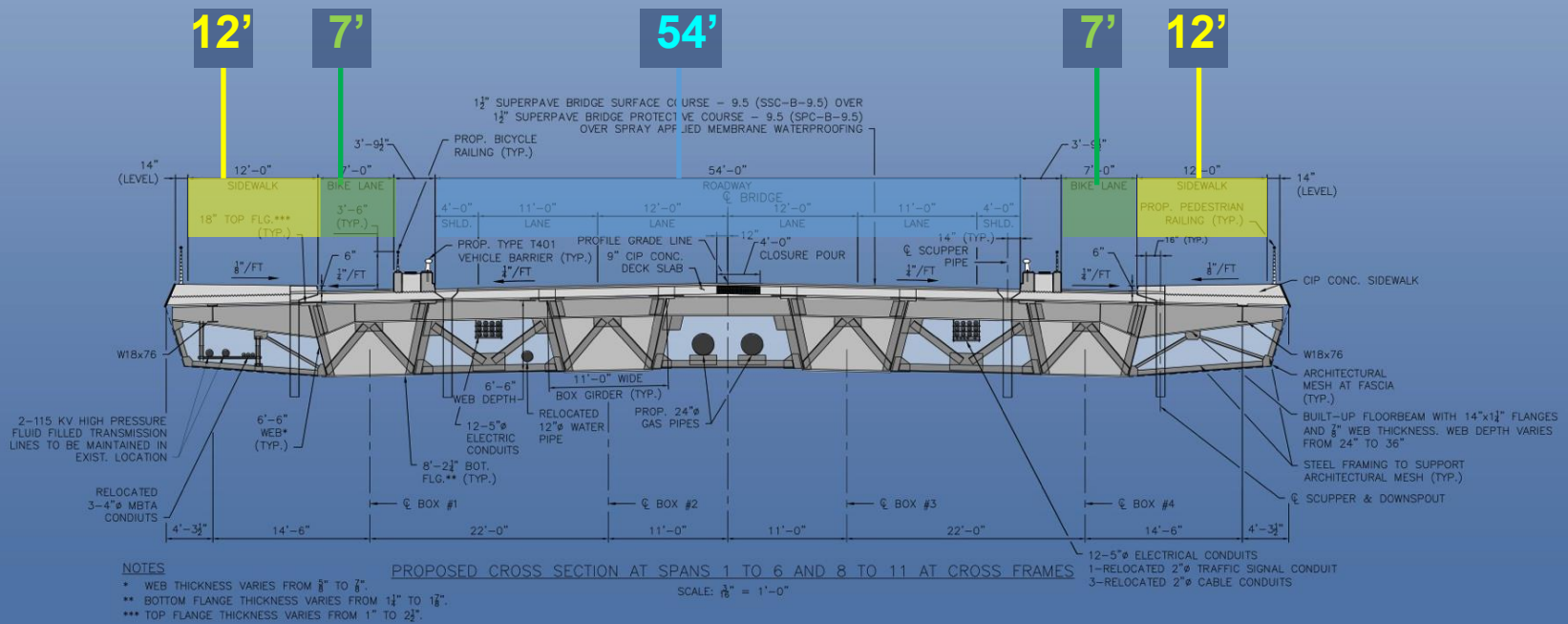

Proposed Bridge Cross Section at Navigation Span

- Pedestrian Overlooks
- Architectural Trellis and Plantings

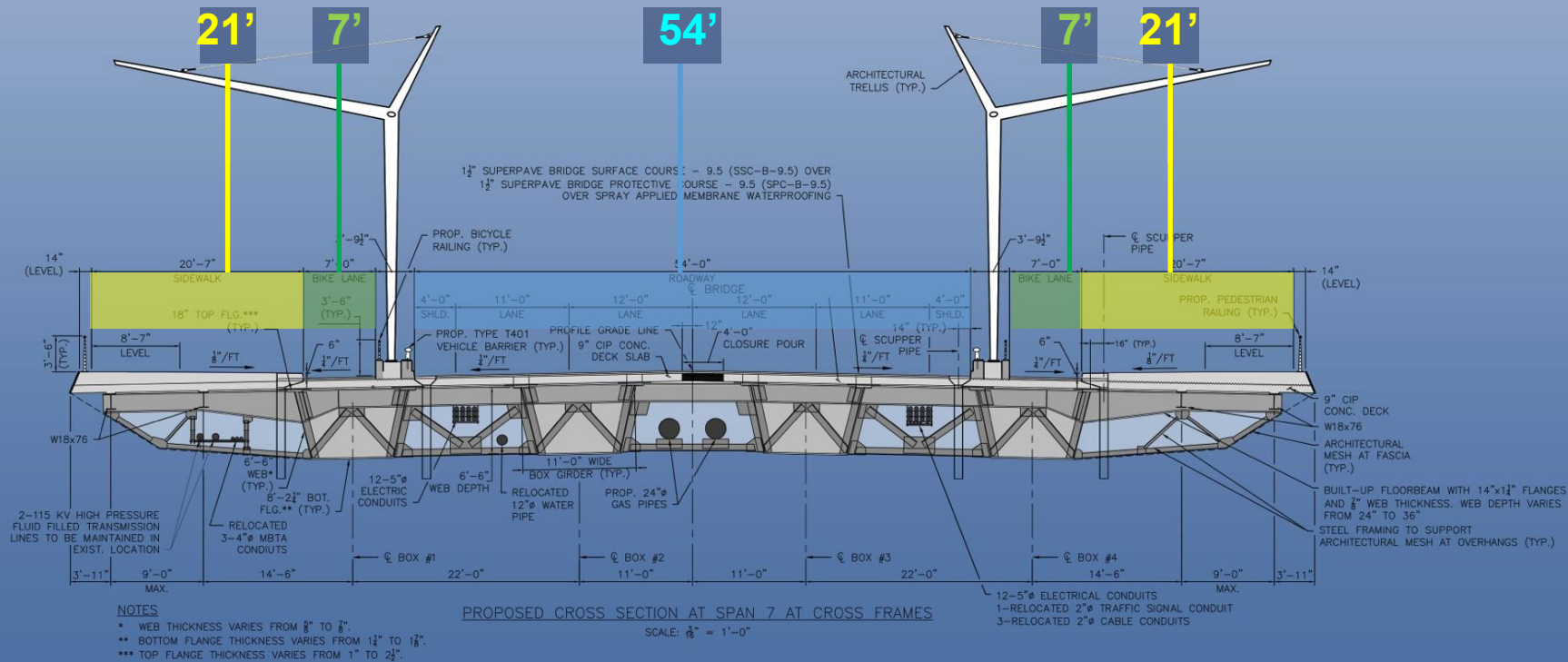

Proposed Bridge Pier Detail

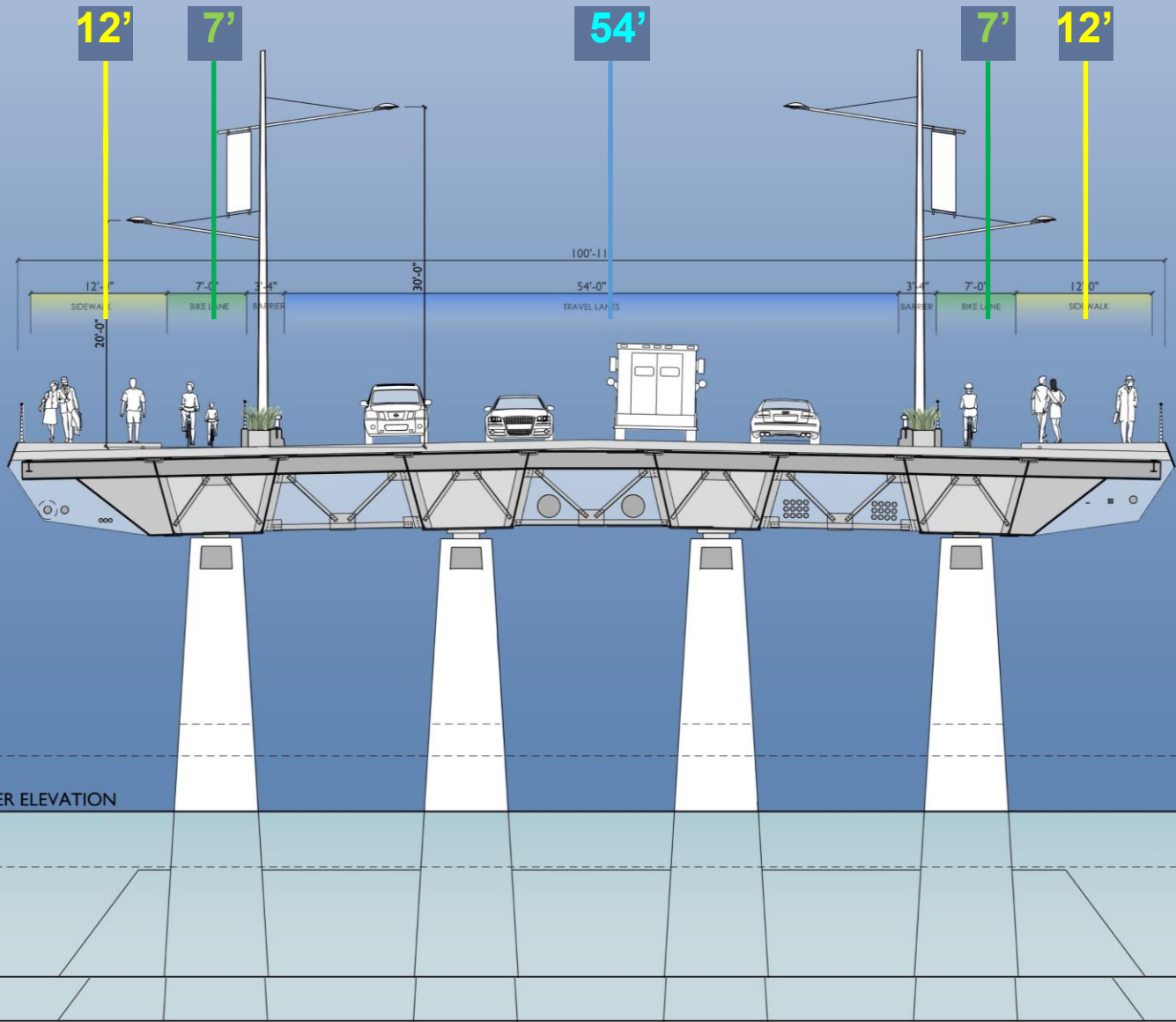

Proposed Bridge Pier Detail

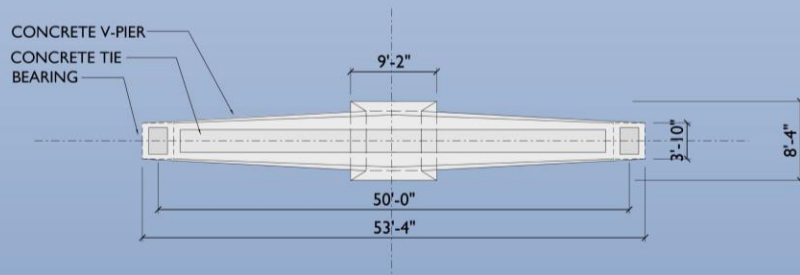

PLAN

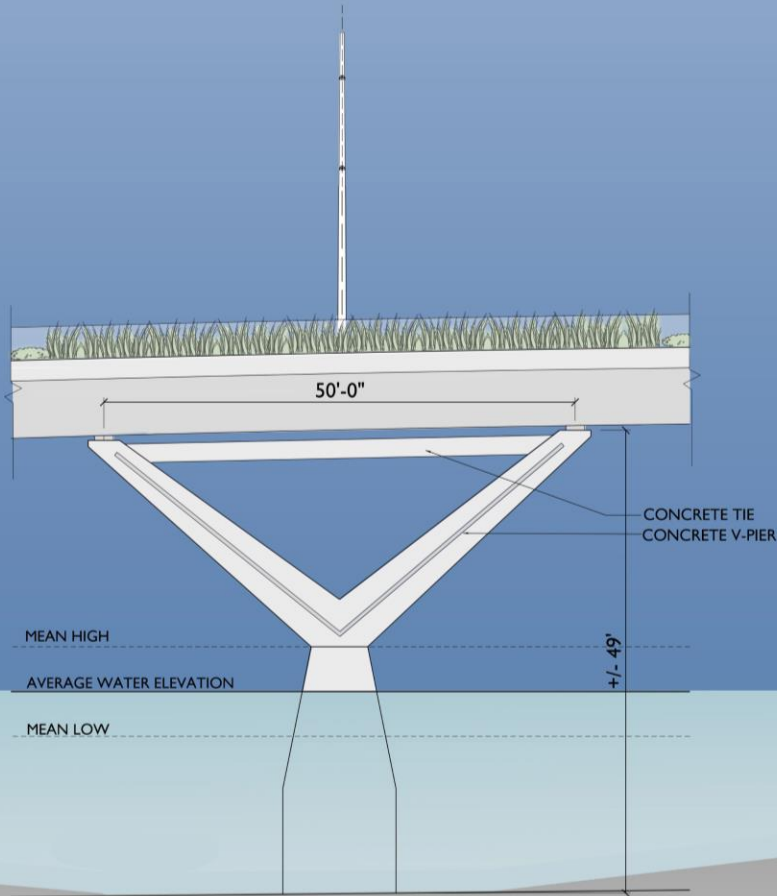
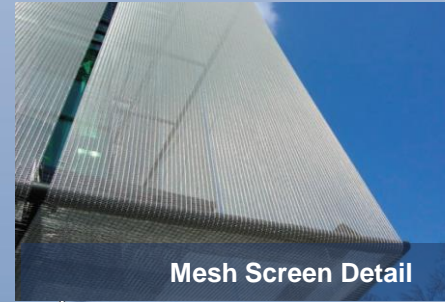

ELEVATION

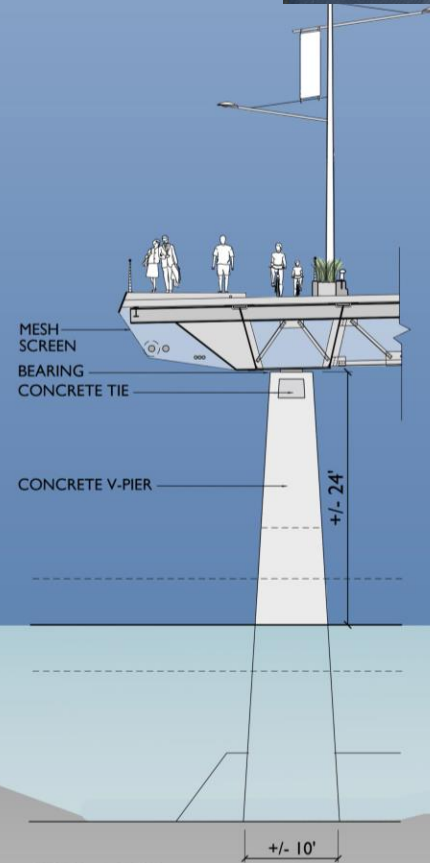

SECTION

Elevation of Architectural Trellis

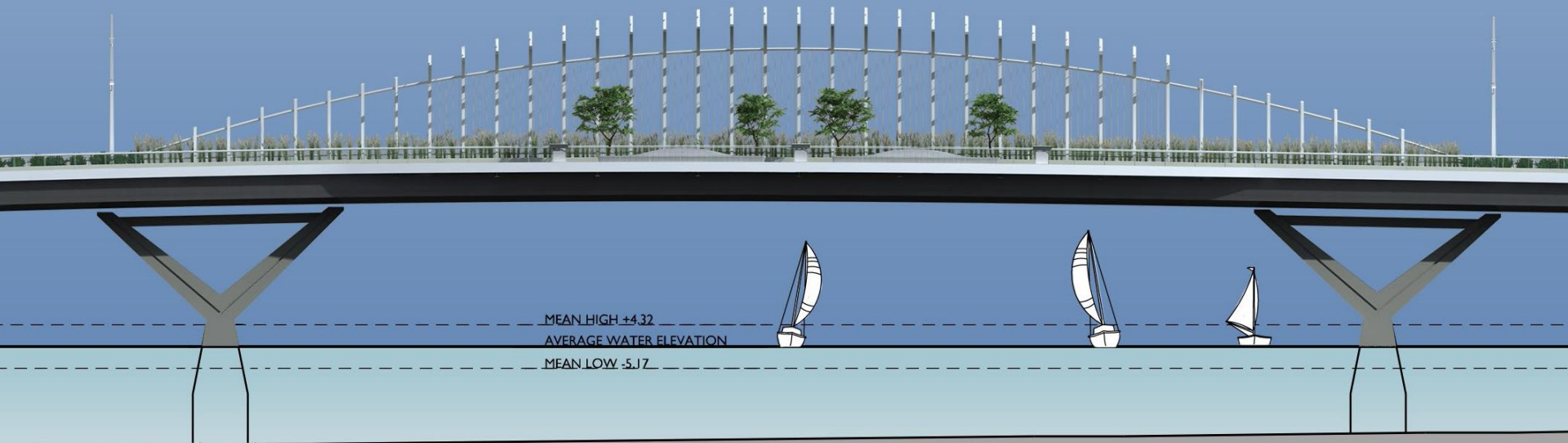

Roadway and Pedestrian Lighting

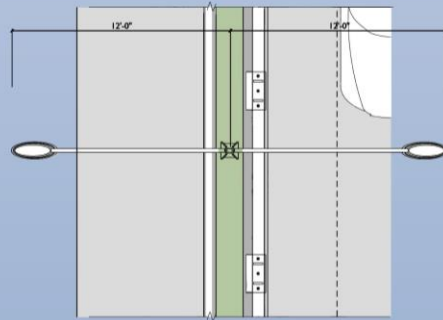

PLAN

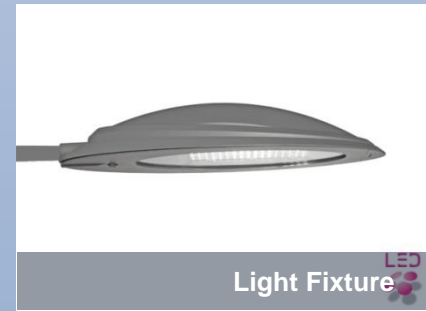

Light Fixture 

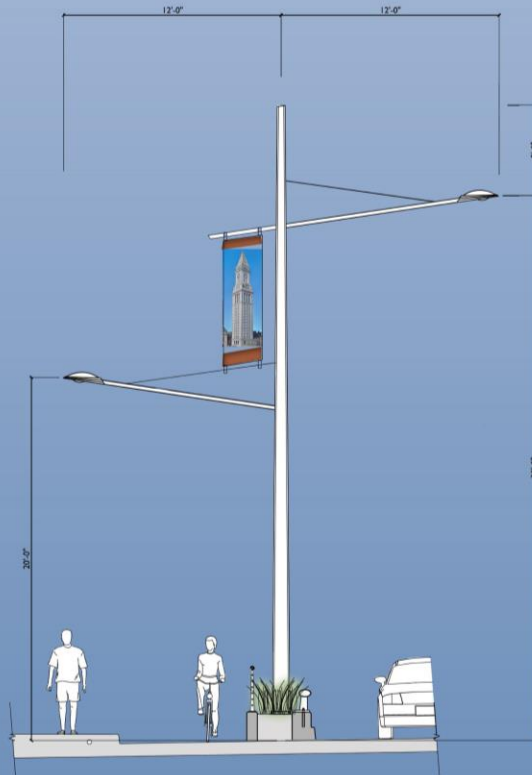

SECTION

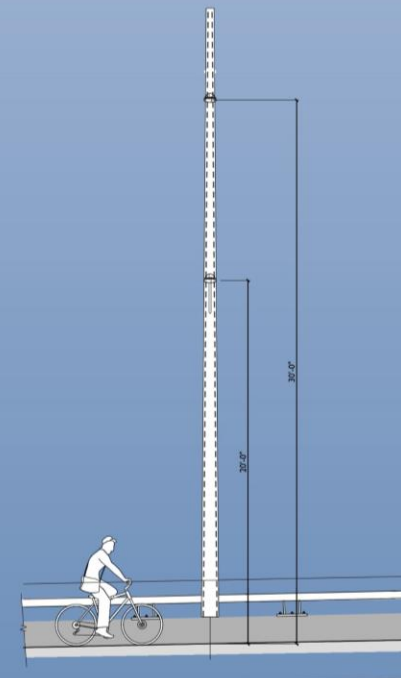

ELEVATION

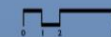

Pedestrian Railing

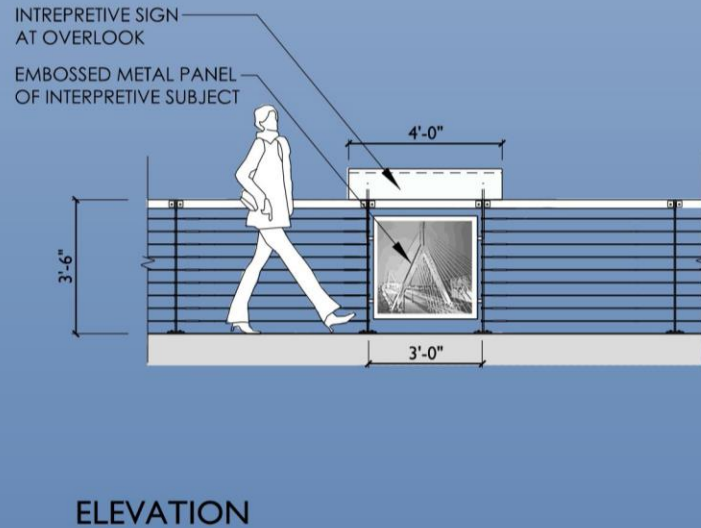
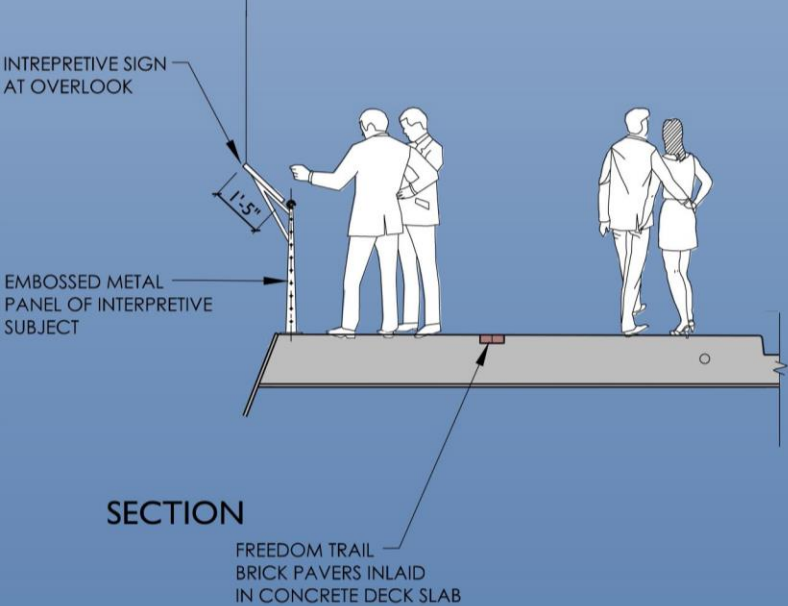
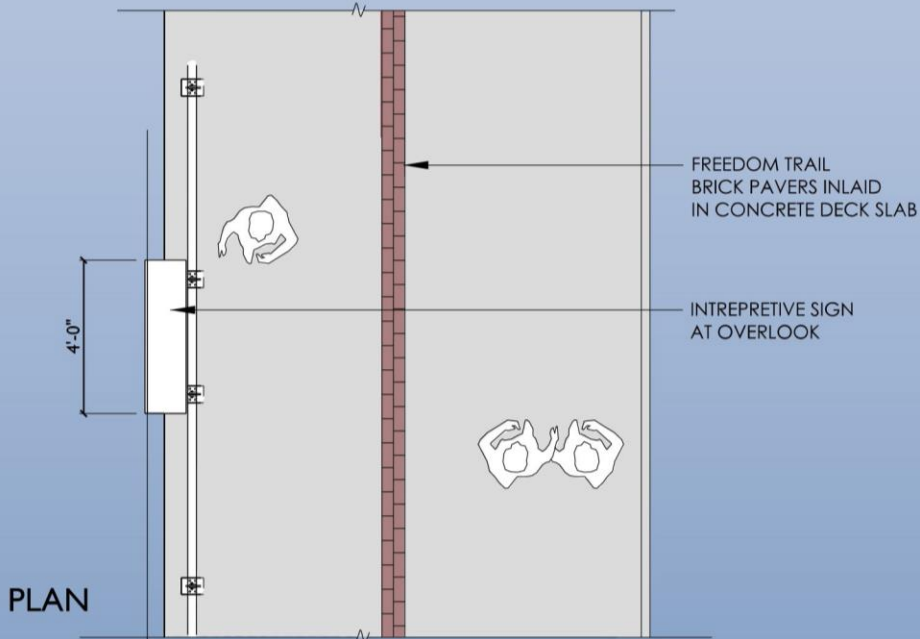

Suggested Themes for Interpretive Signage



**CUSTOM
HOUSE
TOWER**



**BOSTON
GARDEN**



**ZAKIM
BRIDGE**



**OLD
NORTH
CHURCH**

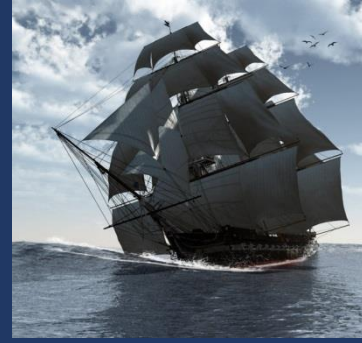

**U.S.
CONSTITUTION**



**BUNKER
HILL
MONUMENT**

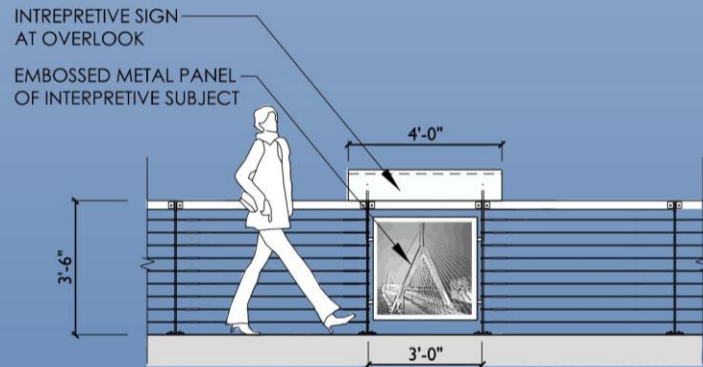
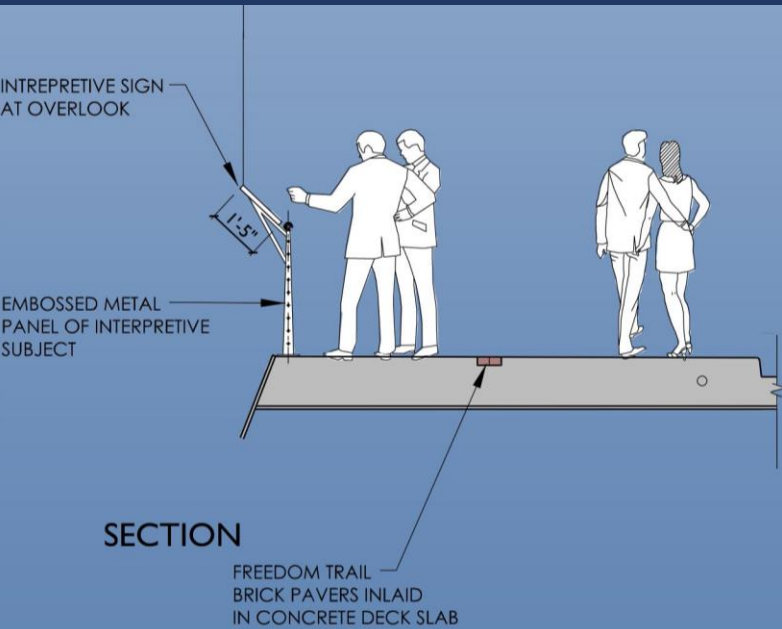

ELEVATION



Vehicular Barrier

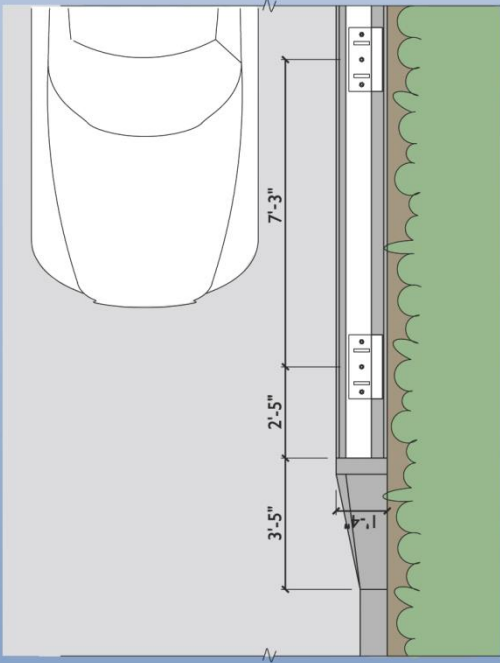

PLAN

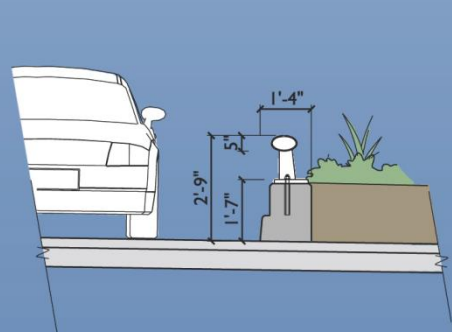

SECTION

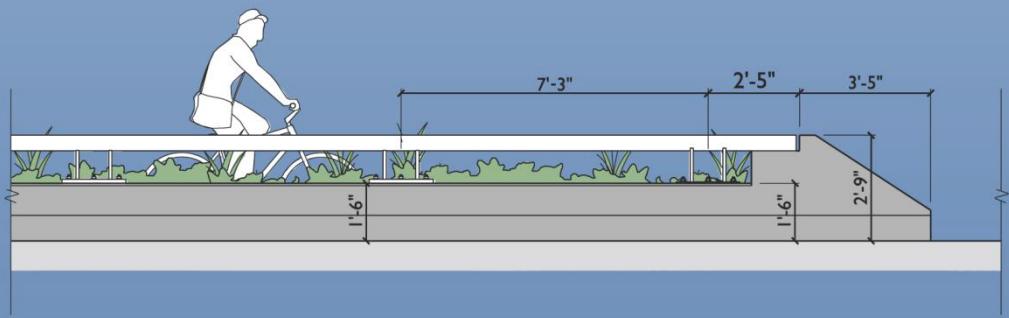

ELEVATION

3D Visualizations



Harbor Walk View





Pedestrian View



Pedestrian View



Motorist View





Pedestrian View at Overlook



Pedestrian View at Overlook



Pedestrian View at Grade Separated Walkway



Proposed Bridge Underside View



Proposed Bridge Night Elevation View



Connectivity Improvements



City Square Intersection Improvements



PAUL REVERE
PARK

CITY SQUARE
PARK

Keany Square Intersection Improvements

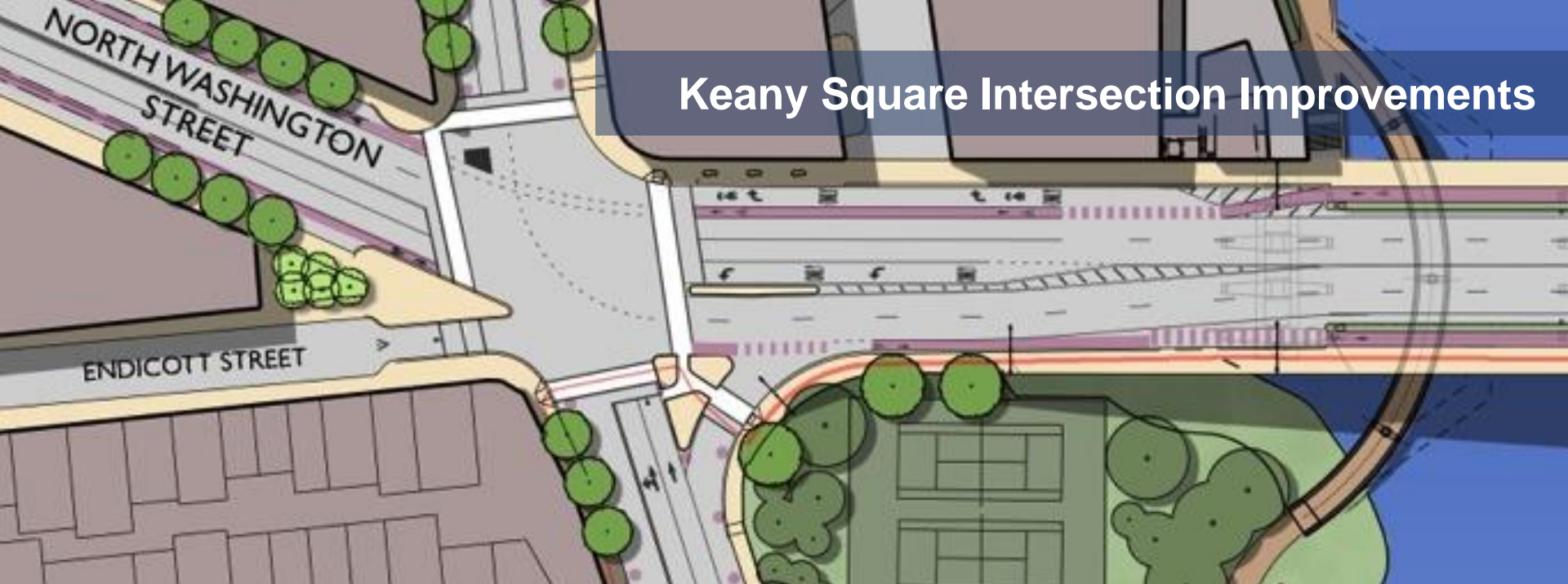

Detailed Plan at Paul Revere Landing Park

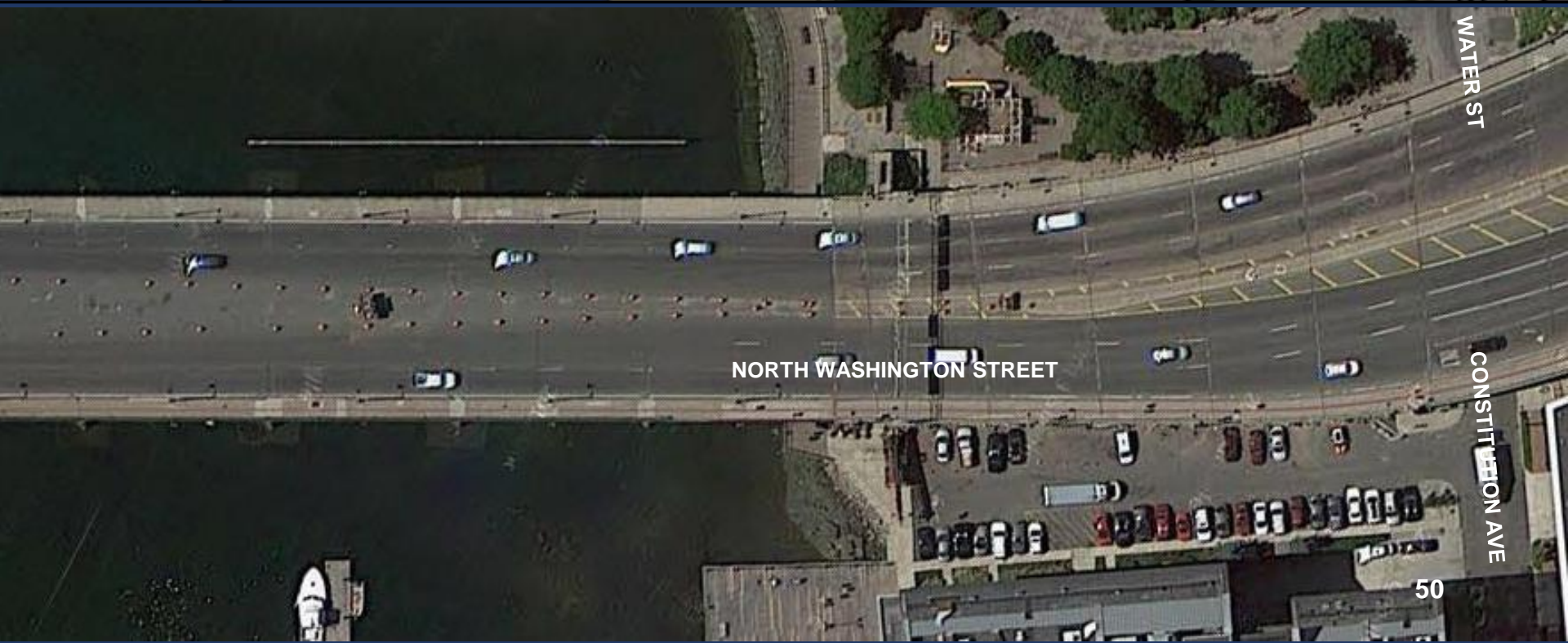

Detail Plan at Grade Separated Walkway

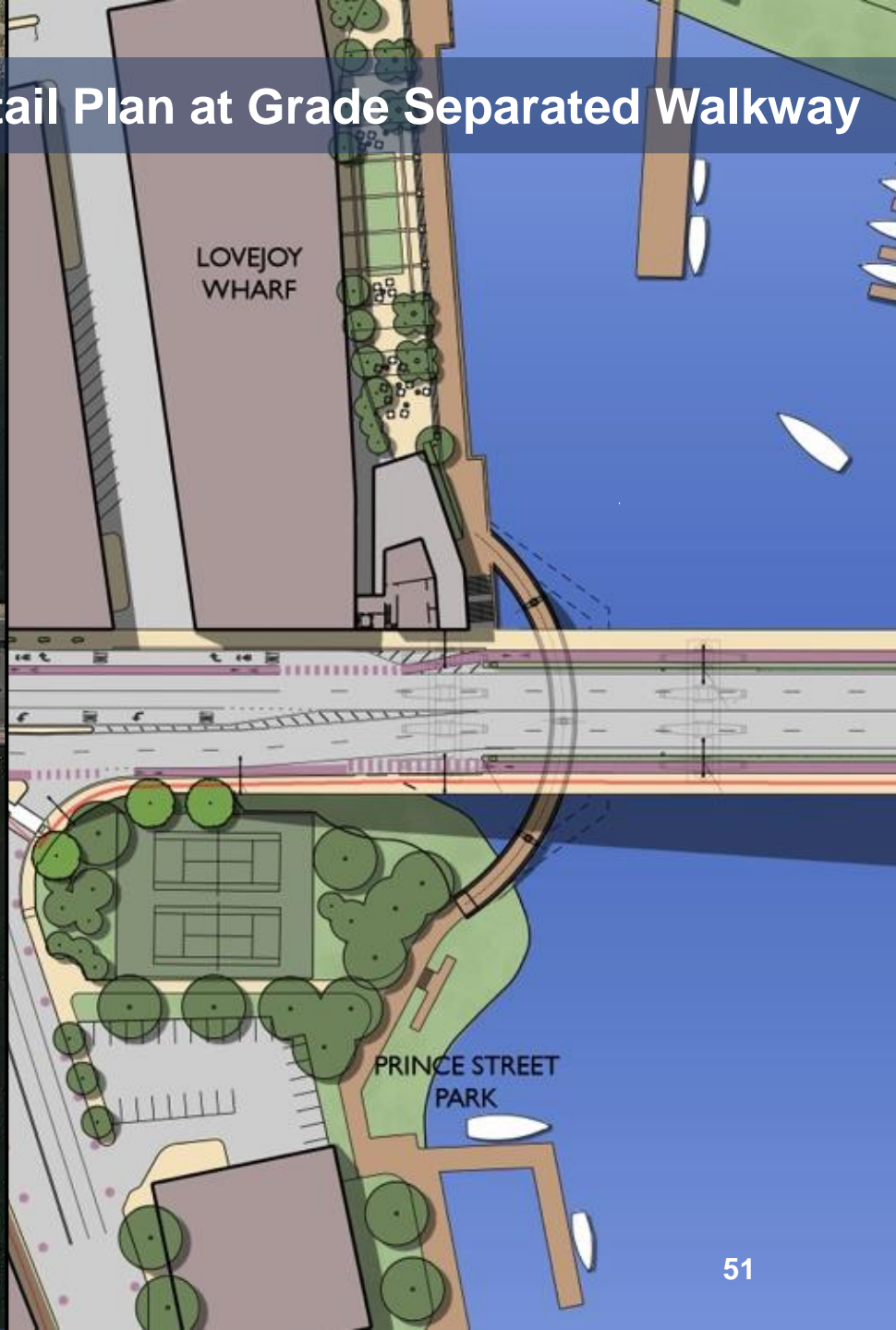

Grade Separated Walkway Pier Detail

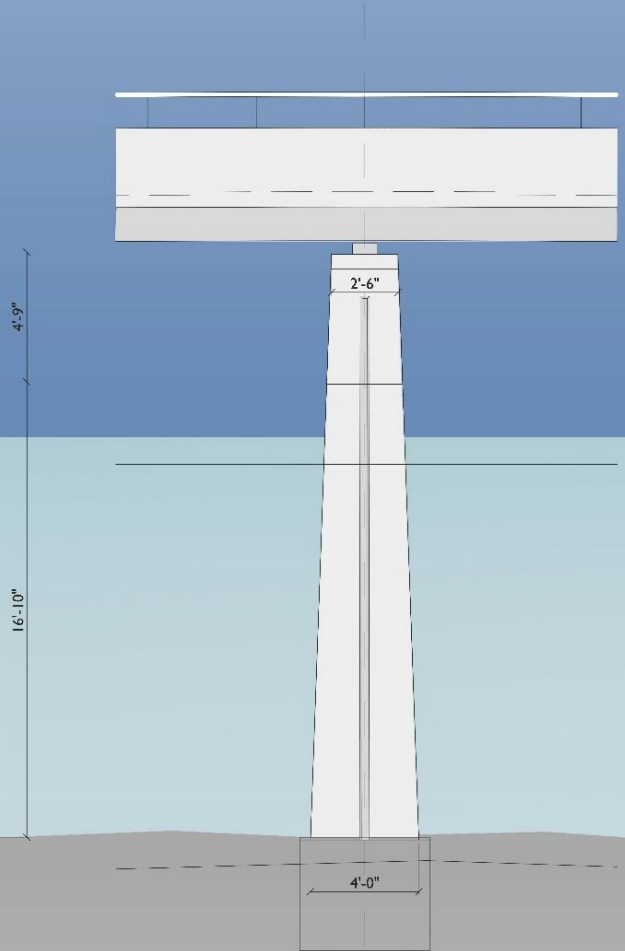
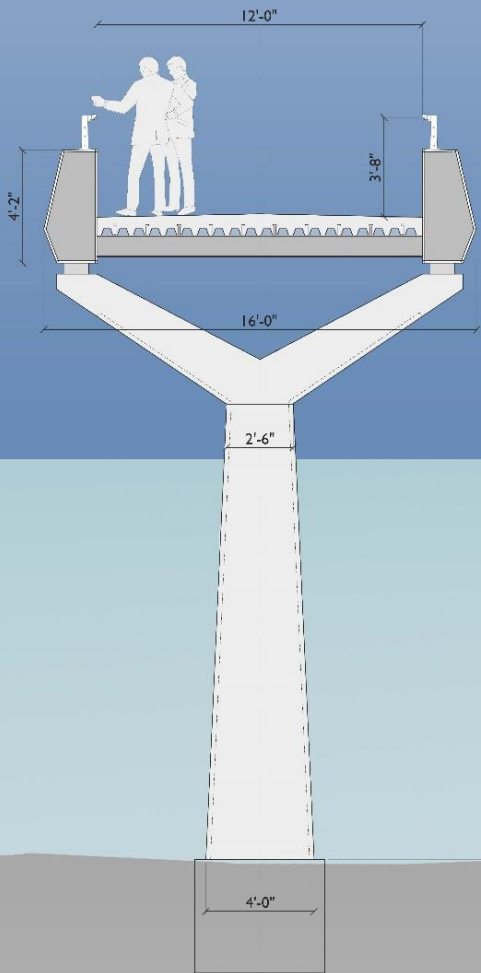
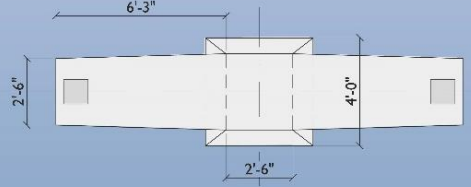

Comparison Before and After Views

Before





After

Before



After





Before

After

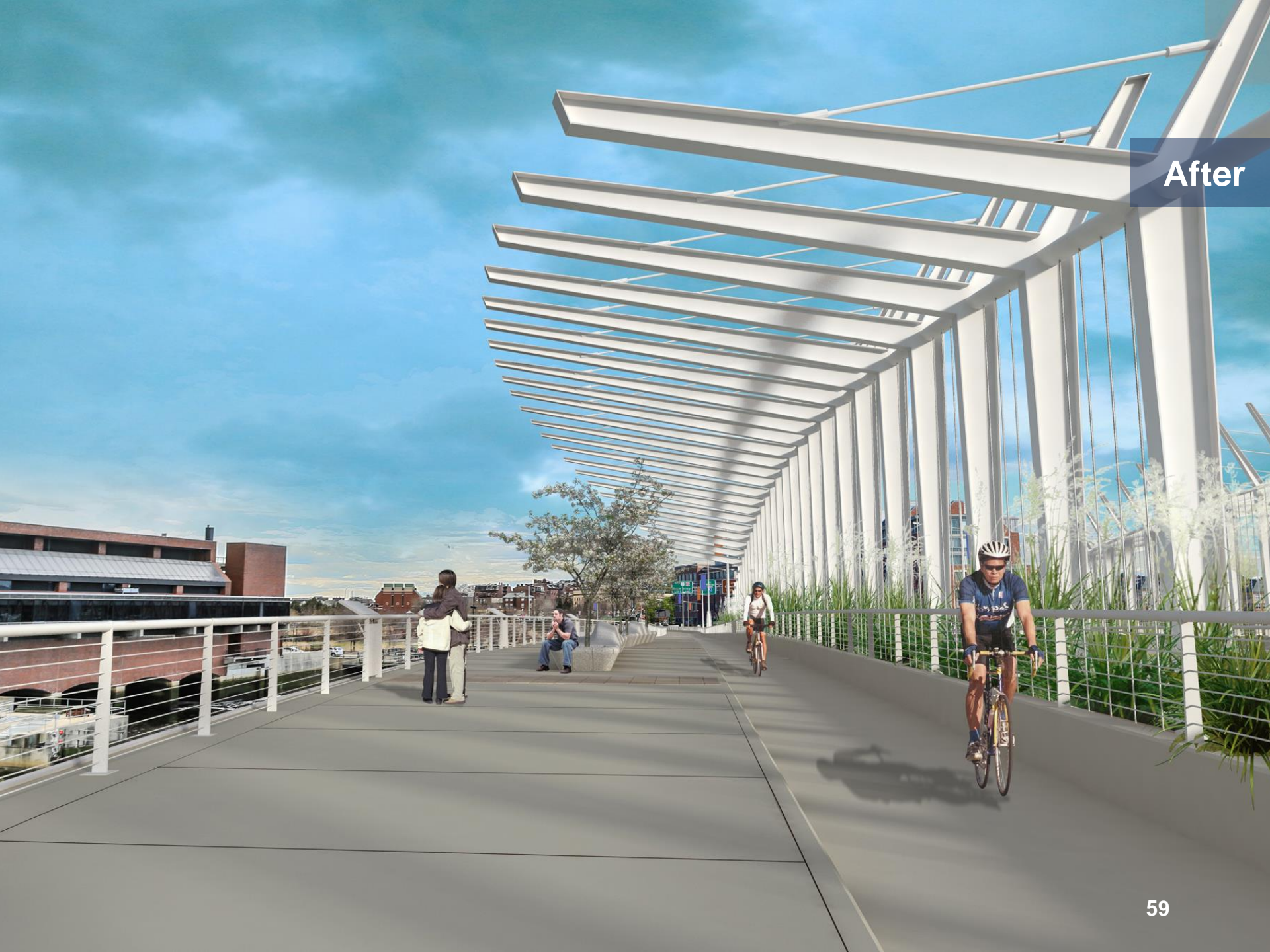

- FHWA is Lead Agency
- U.S. Coast Guard
- U.S. Army Corps of Engineers – Individual Permit
- Massachusetts Coastal Zone Management (CZM)
- National Marine Fisheries Service (NMFS)/Essential Fish Habitat Assessment (EFH)/Section 7 Consultation
- FHWA - Categorical Exclusion Determination (CE Checklist)
- FHWA - Section 4(f) de Minimis Impact to Park and Recreation Lands
- FHWA - Section 106 National Historic Preservation Act - Coordination with State Historic Preservation Officer and Boston Landmarks Commission
- MassDEP - Section 401 Water Quality Certification
- Water Quality Data Form (WQDF)/Stormwater Management
- Early Environmental Coordination Checklist (EECC)

Construction Sequence and Traffic Impacts

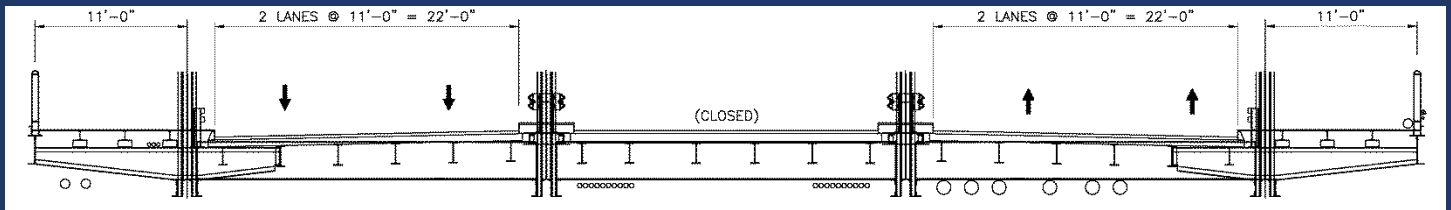
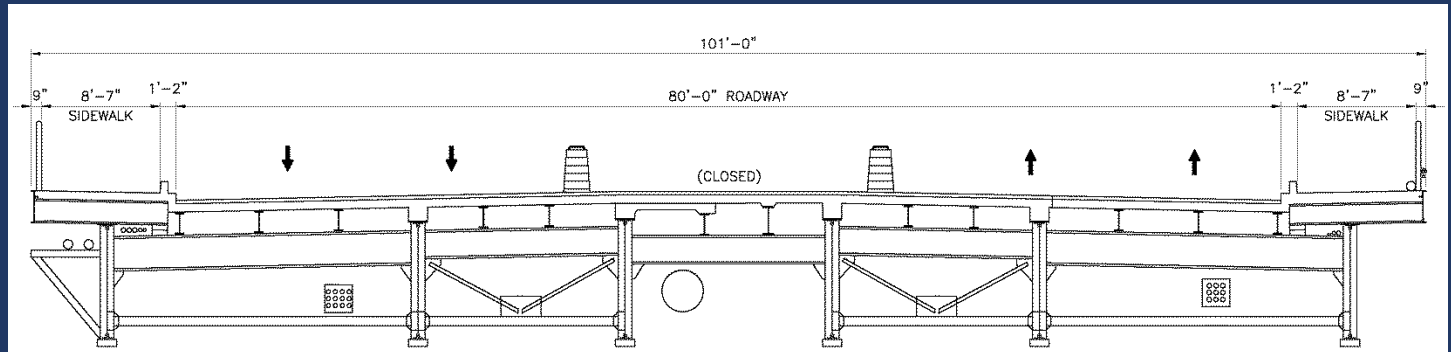
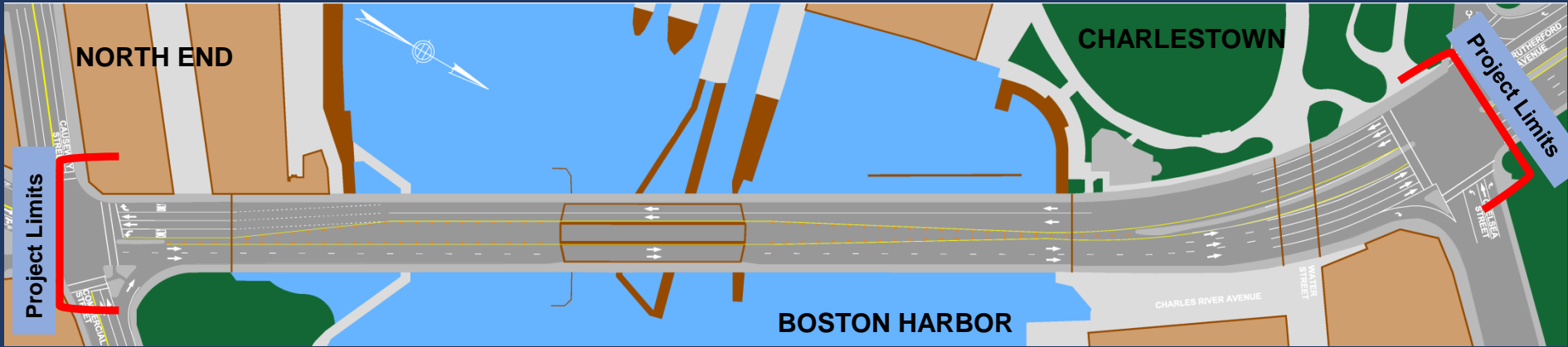

Existing

Construction Sequence and Traffic Impacts

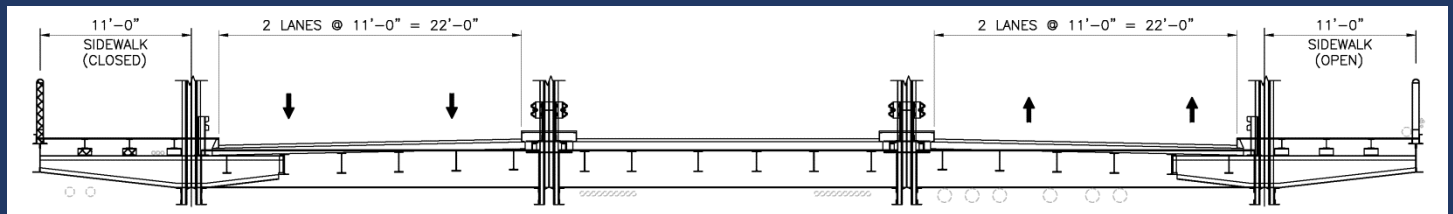
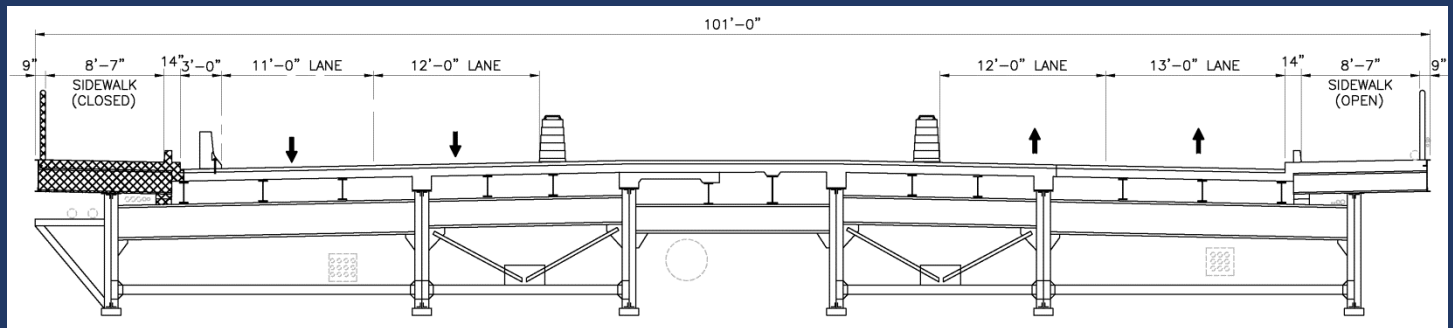
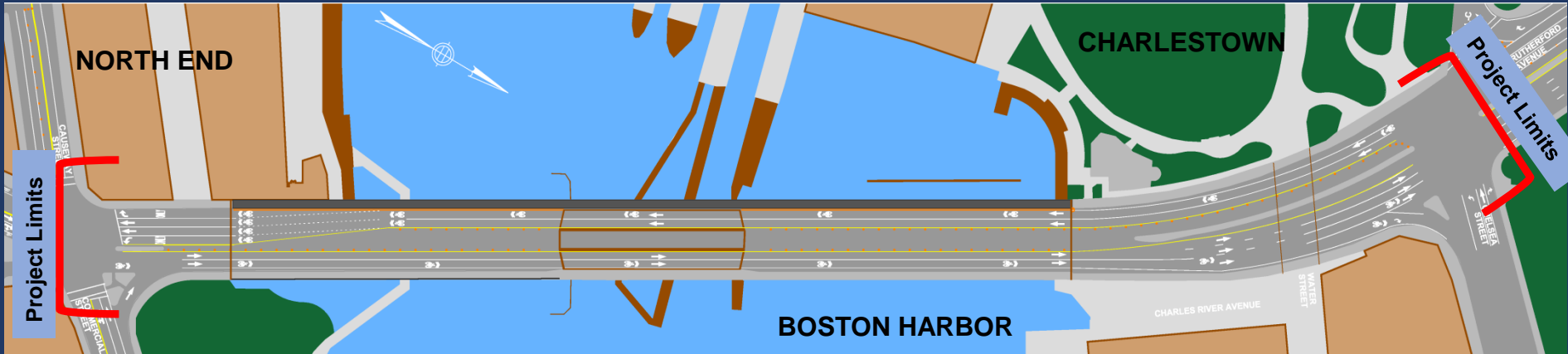

Stage 1A

Construction Sequence and Traffic Impacts

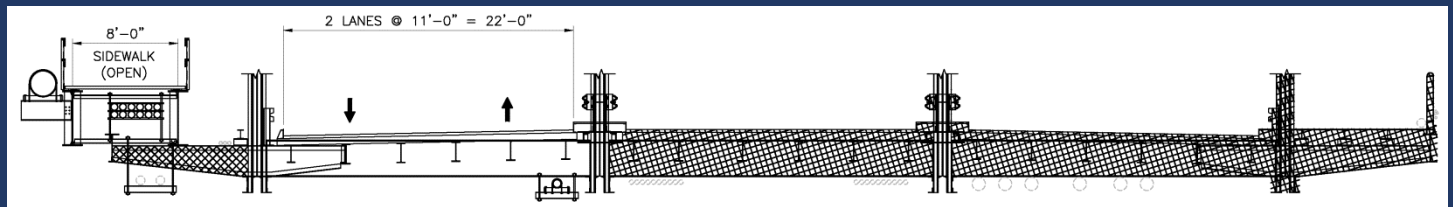
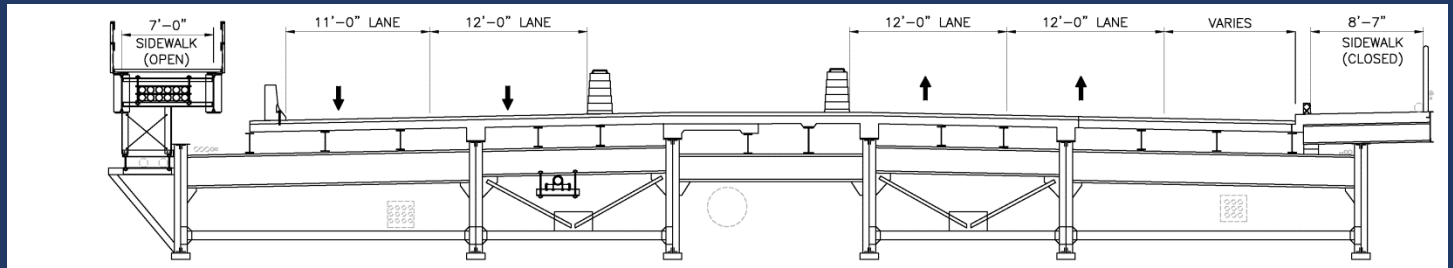
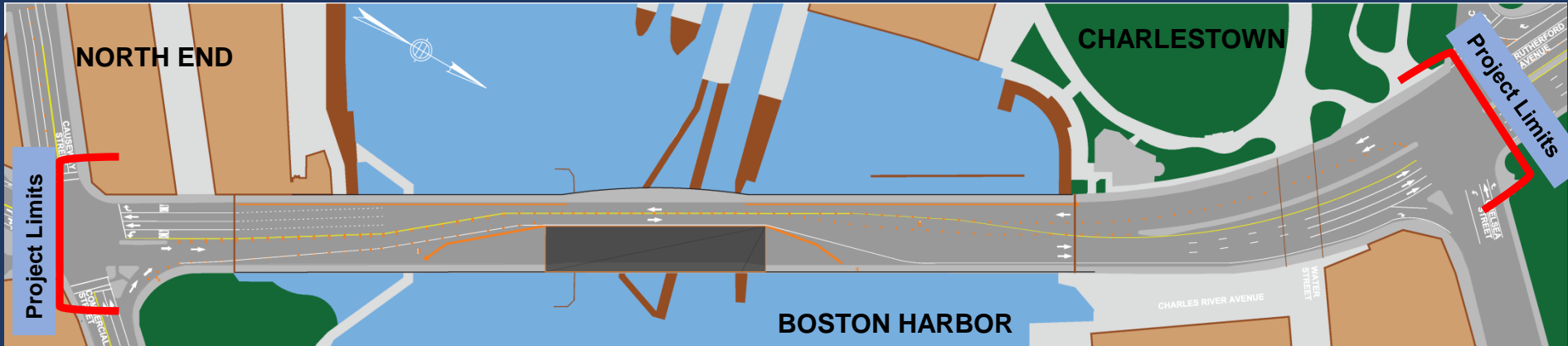

Stage 1B

Construction Sequence and Traffic Impacts



Stage 1B Detour

Construction Sequence and Traffic Impacts

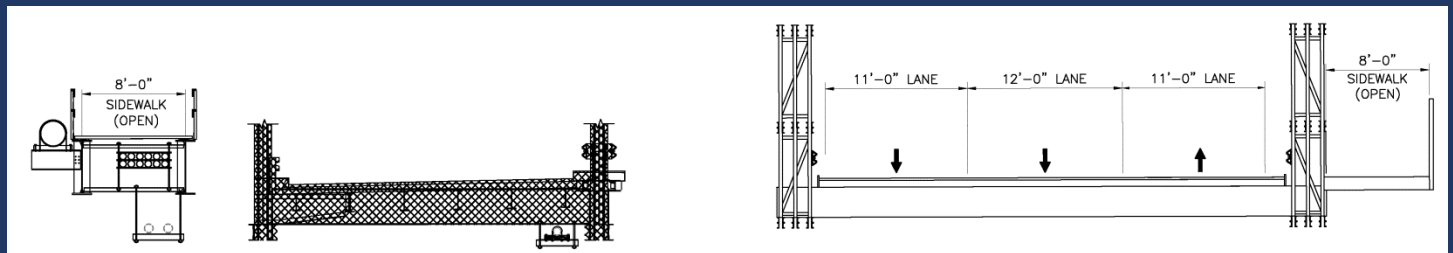
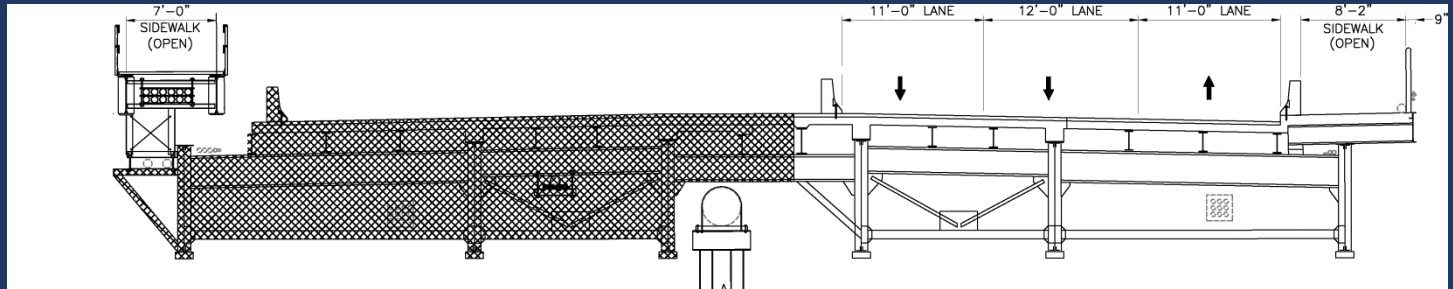
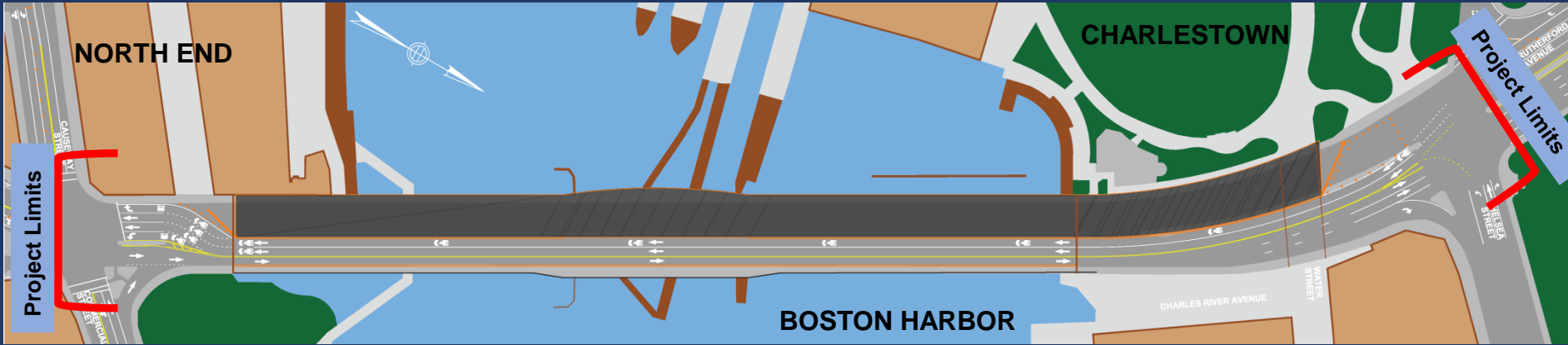

Stage 2

Construction Sequence and Traffic Impacts

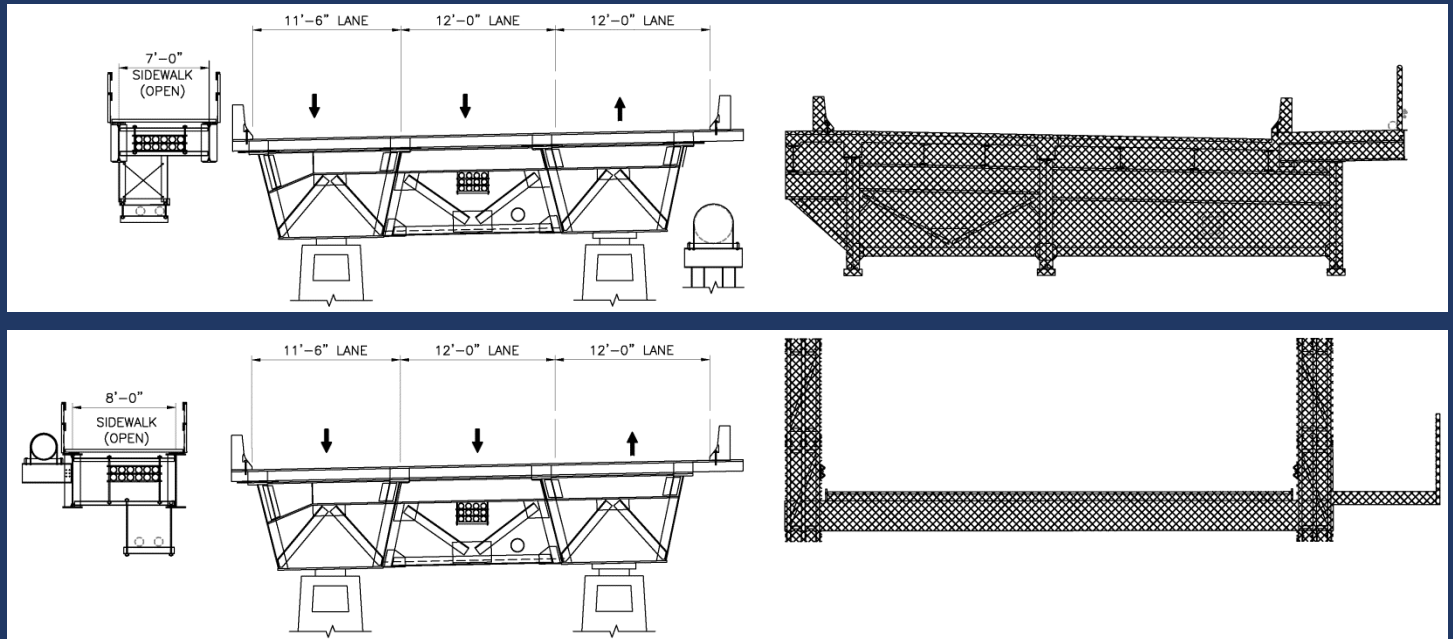
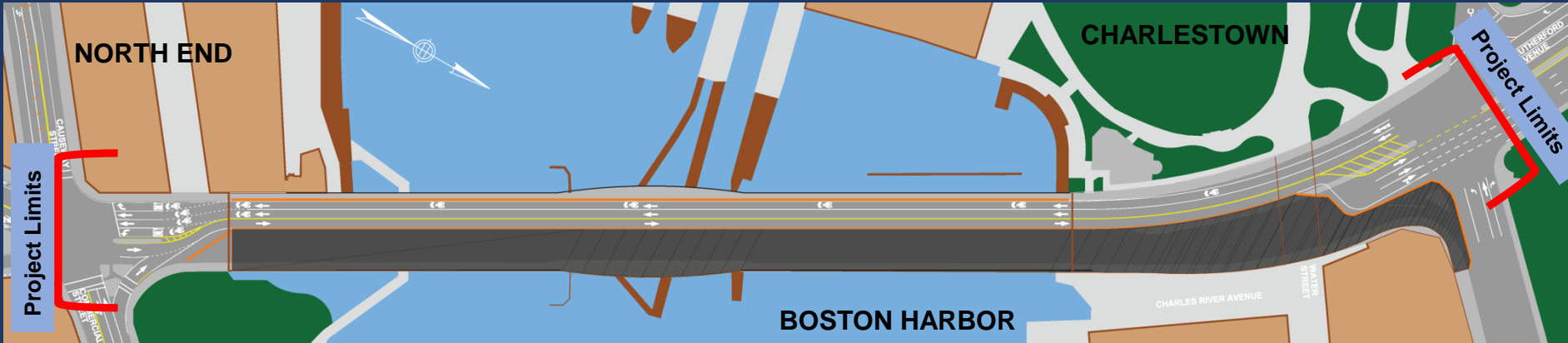

Stage 3

Construction Sequence and Traffic Impacts

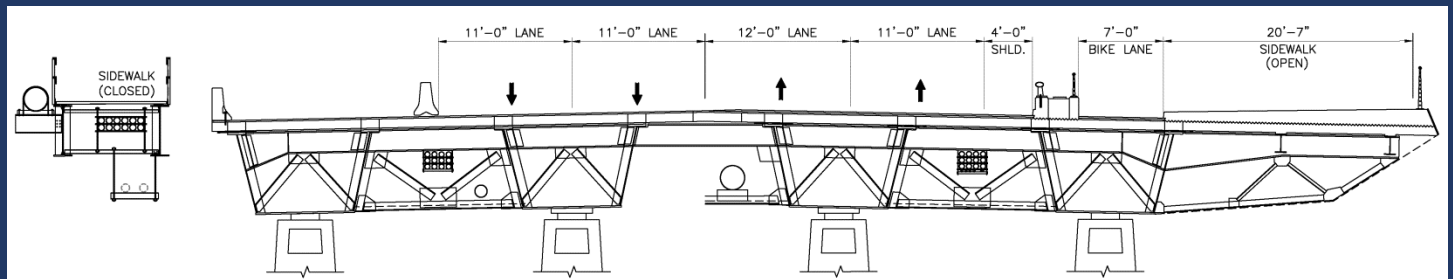
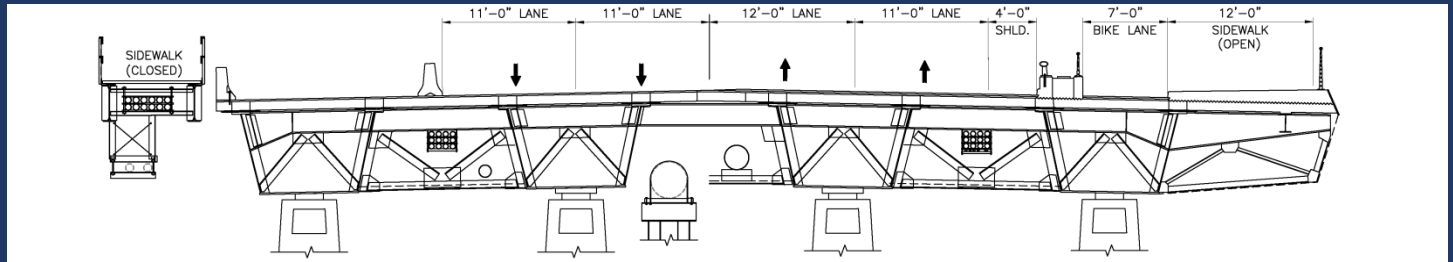
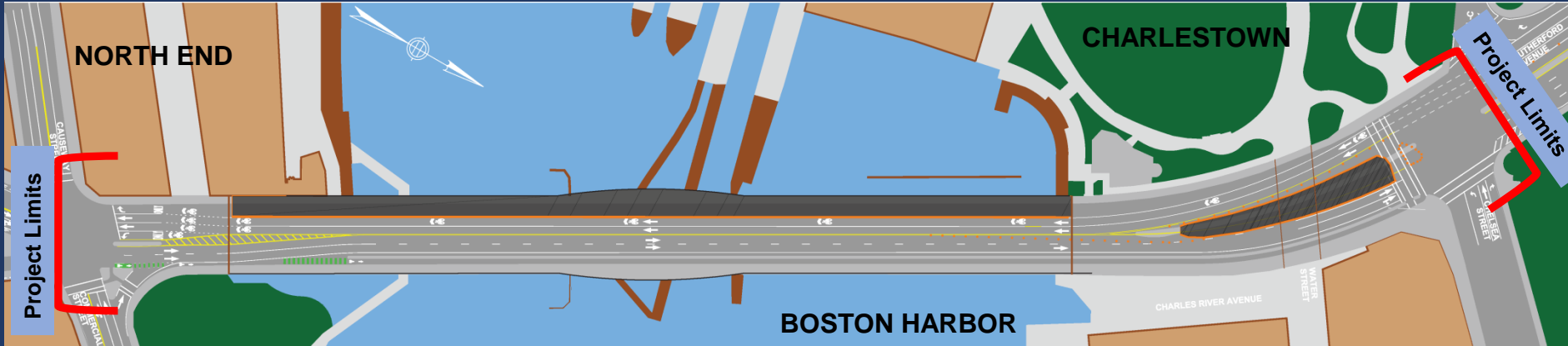

Stage 4A

Construction Sequence and Traffic Impacts

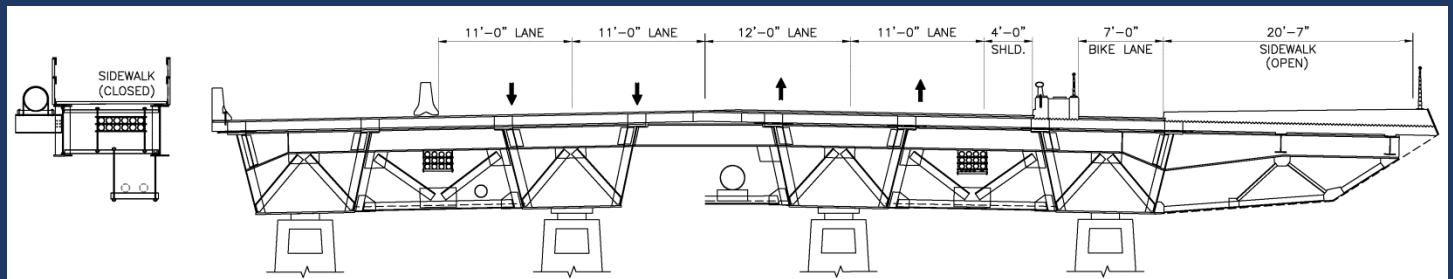
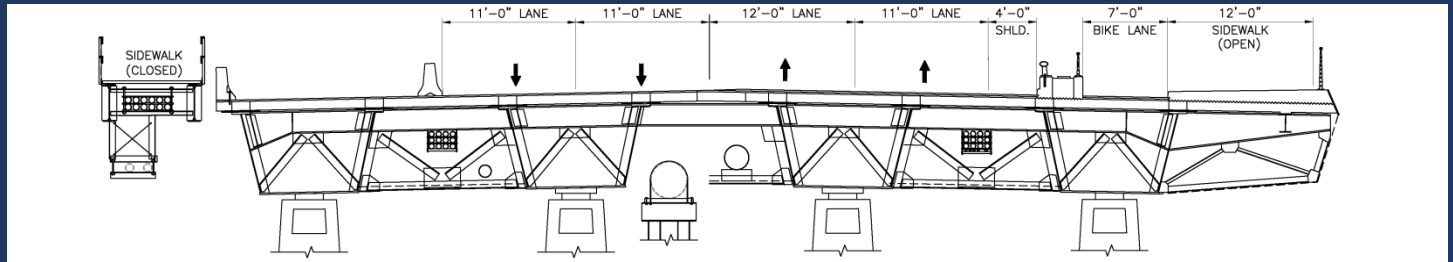
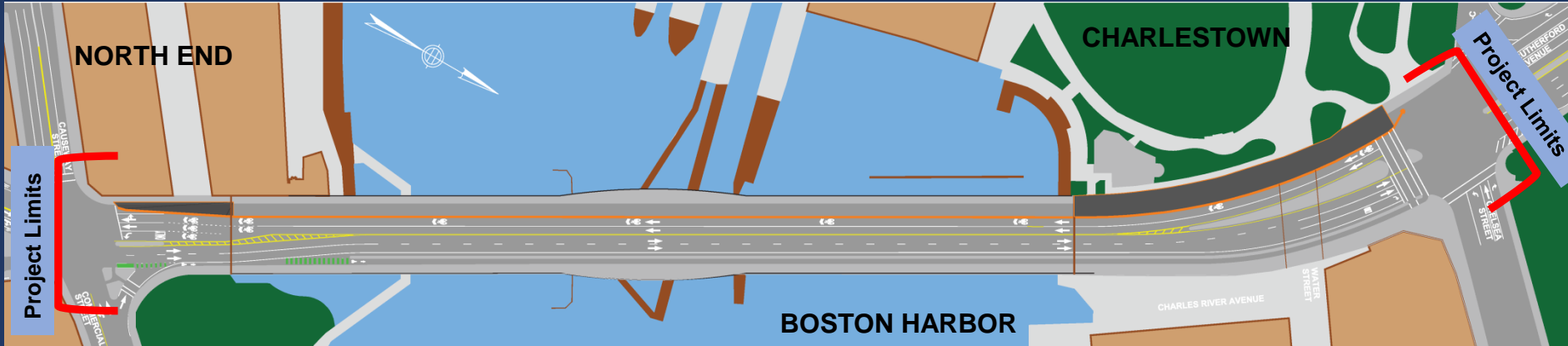

Stage 4B

Construction Sequence and Traffic Impacts

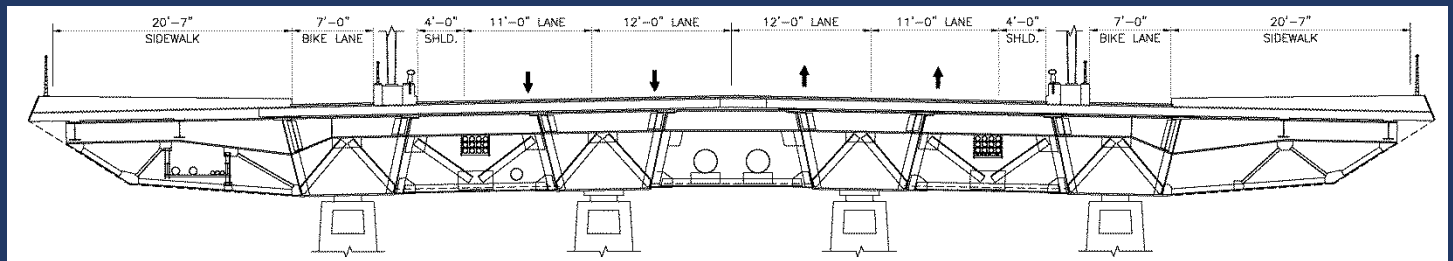
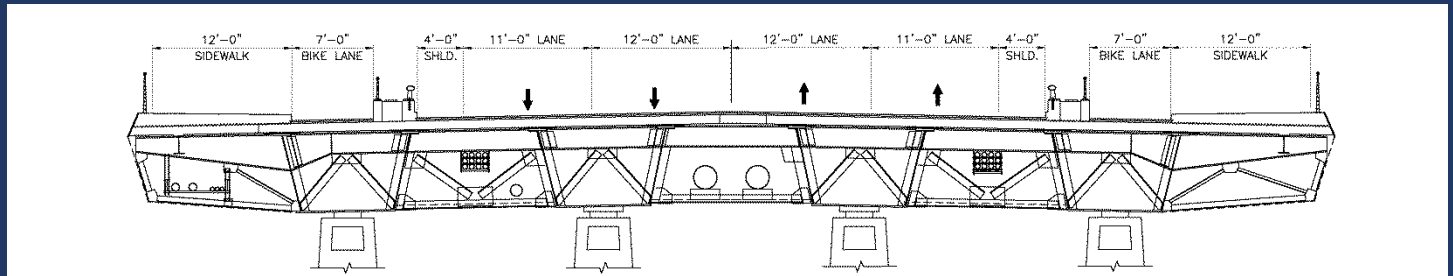
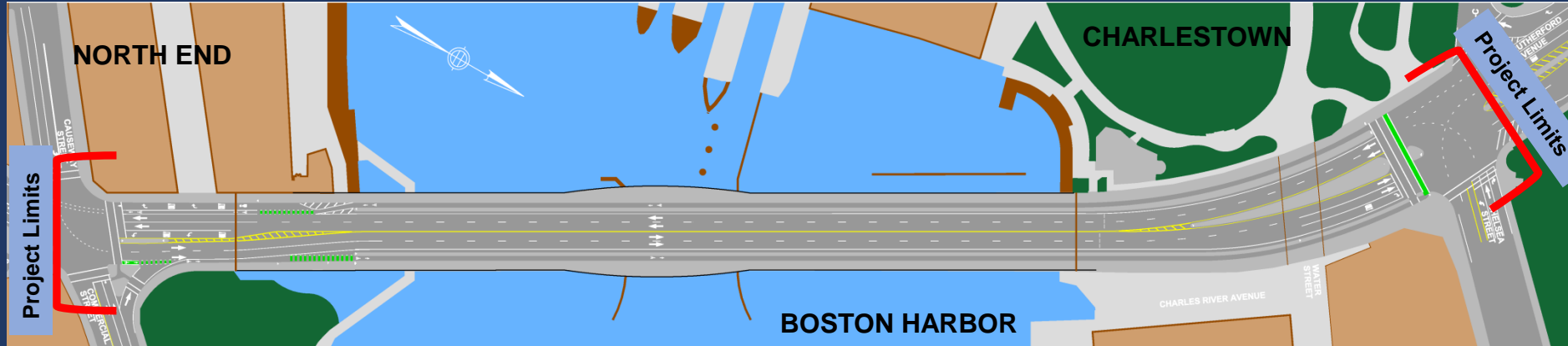

Final

Right - Of - Way Impacts

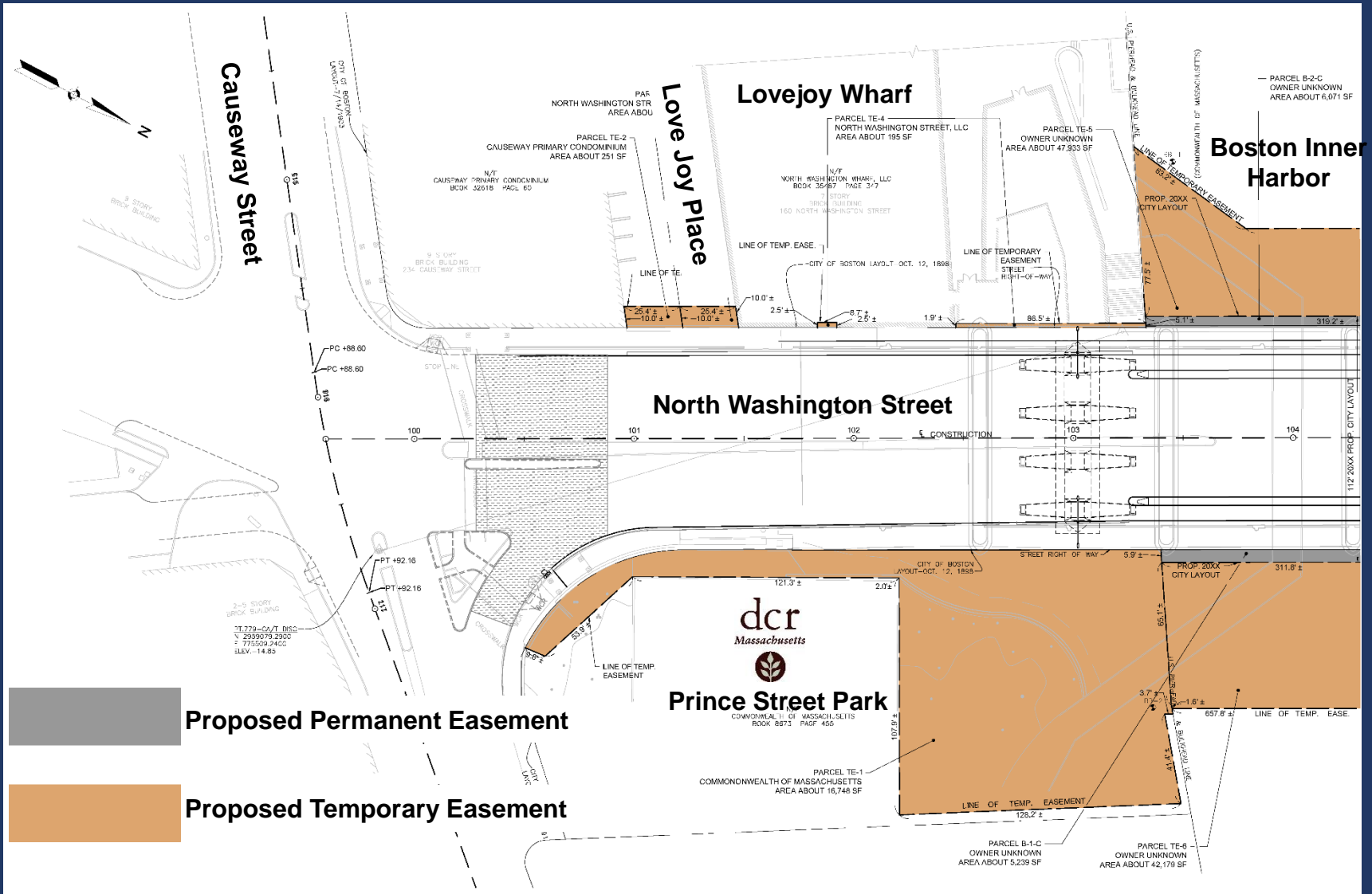

Right - Of - Way Impacts

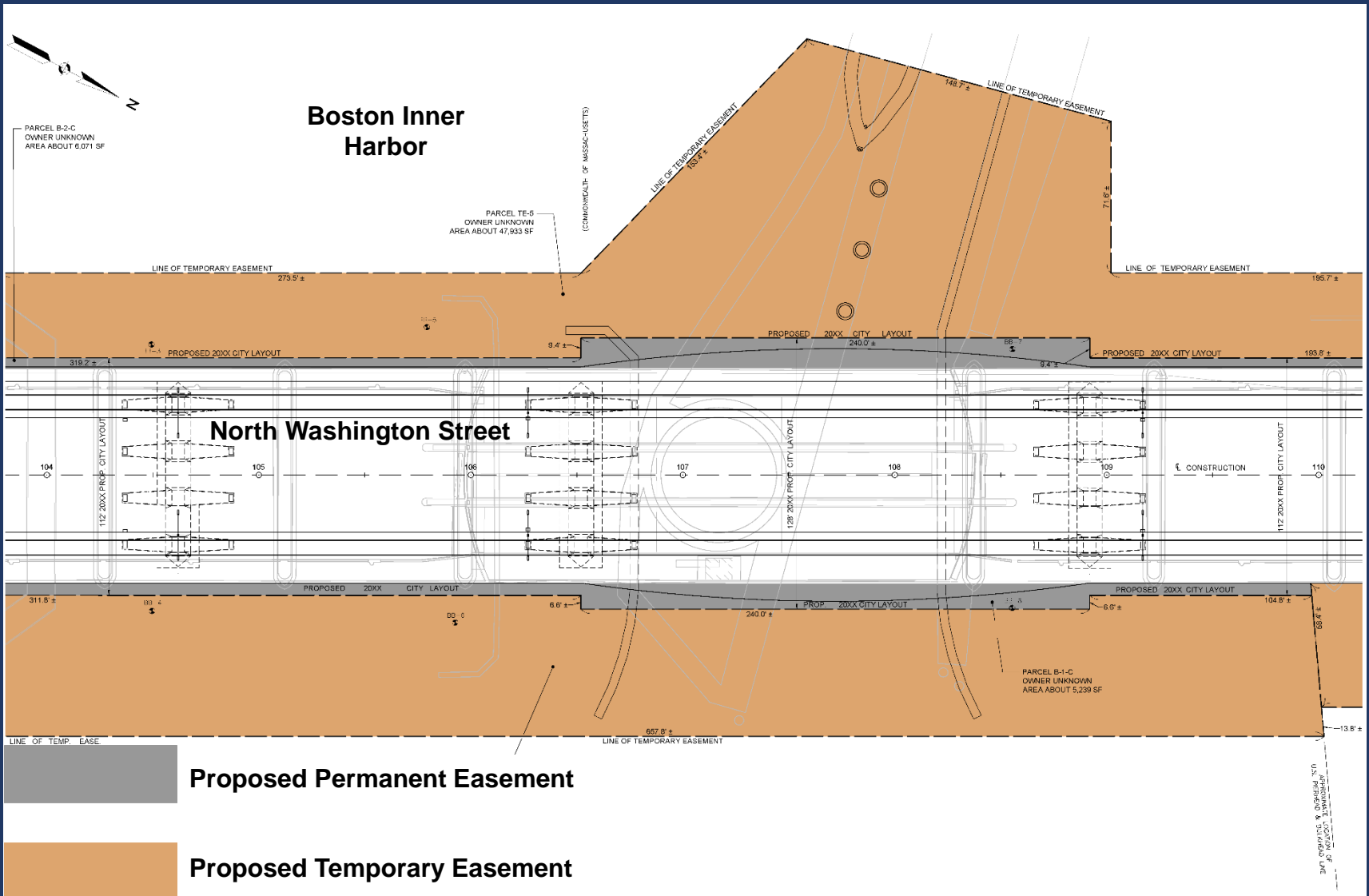

Right - Of - Way Impacts

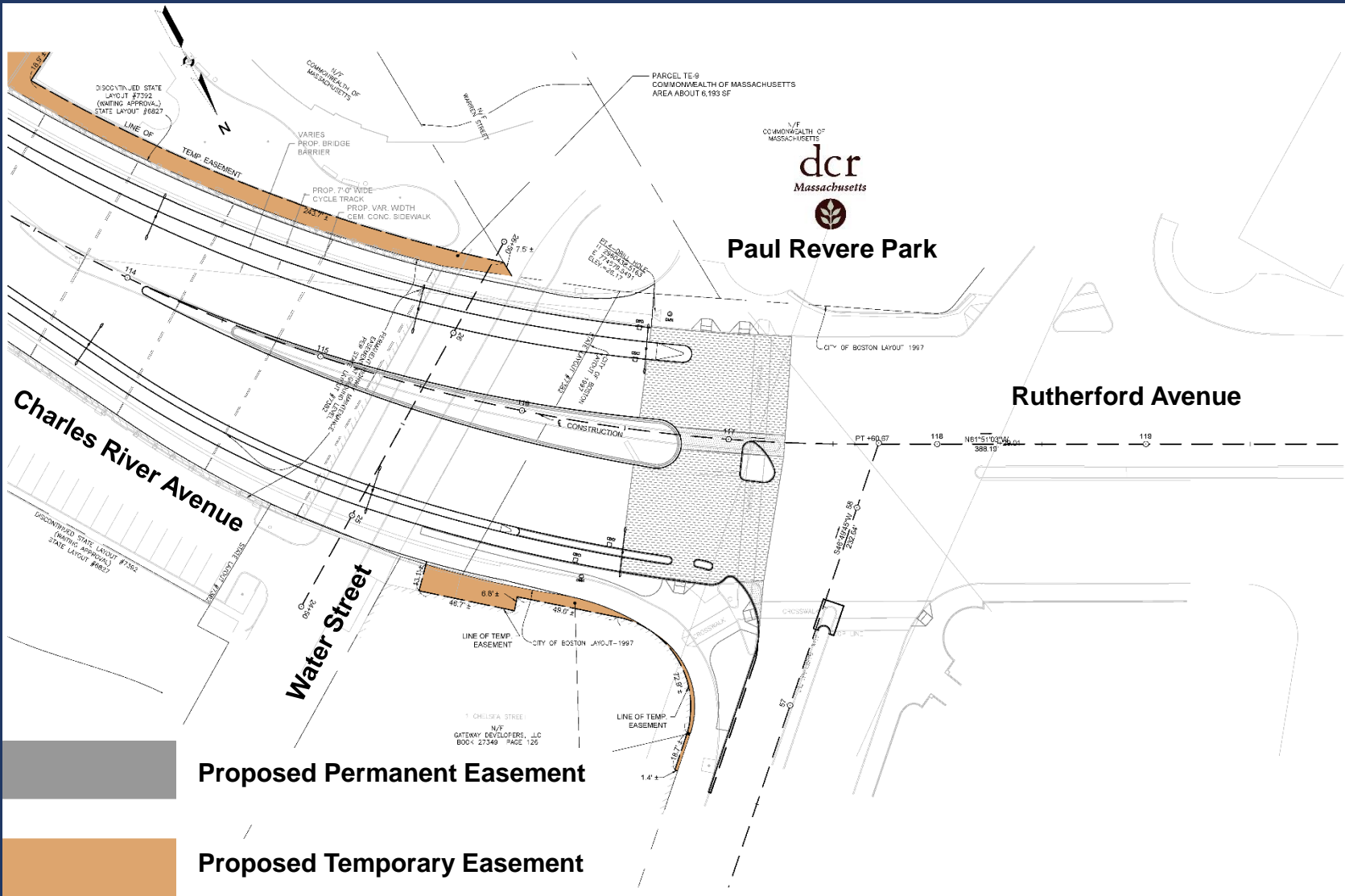

Proposed Permanent Easement

Proposed Temporary Easement

Fender System and Navigational Channel

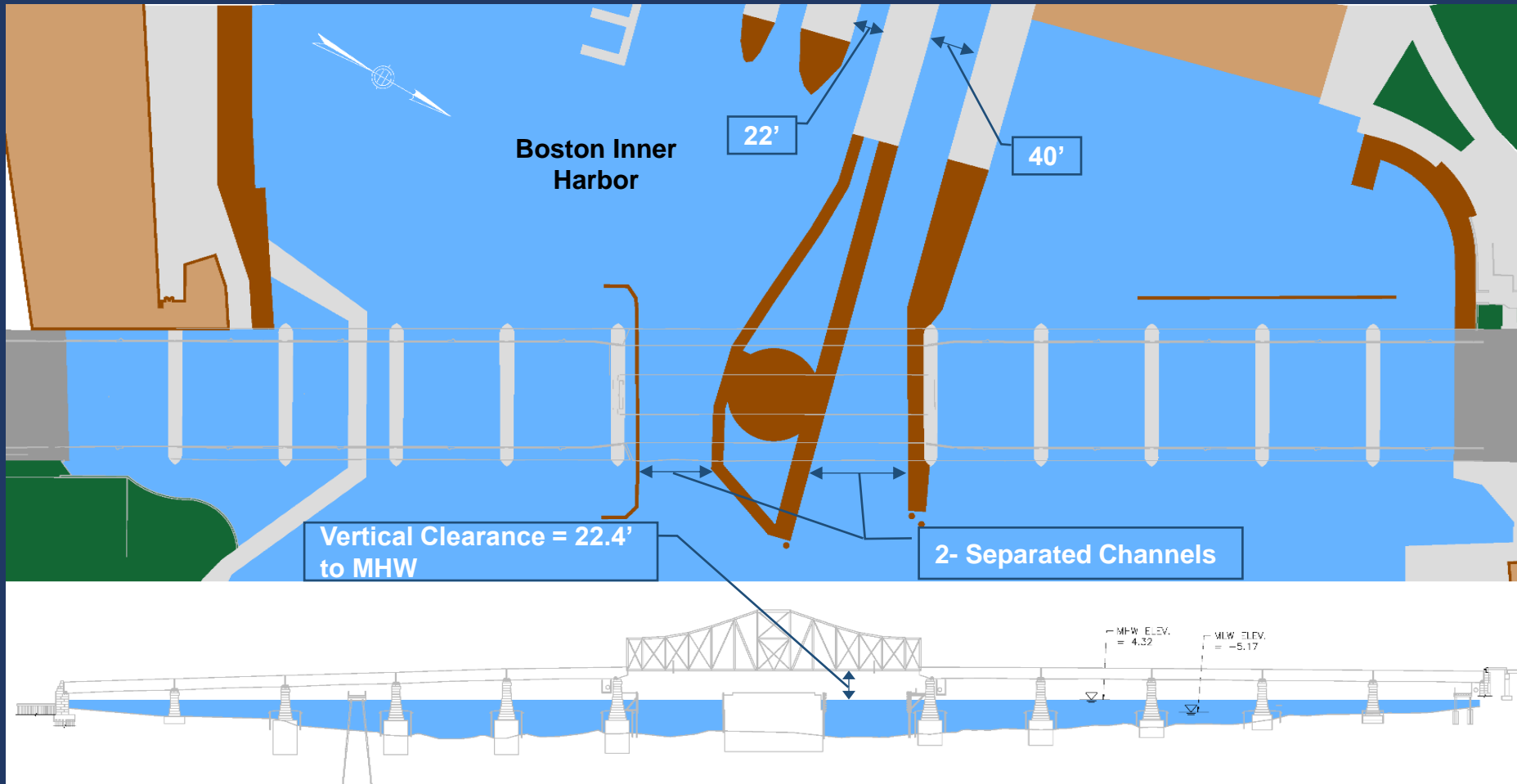

Existing Fender System

Fender System and Navigational Channel

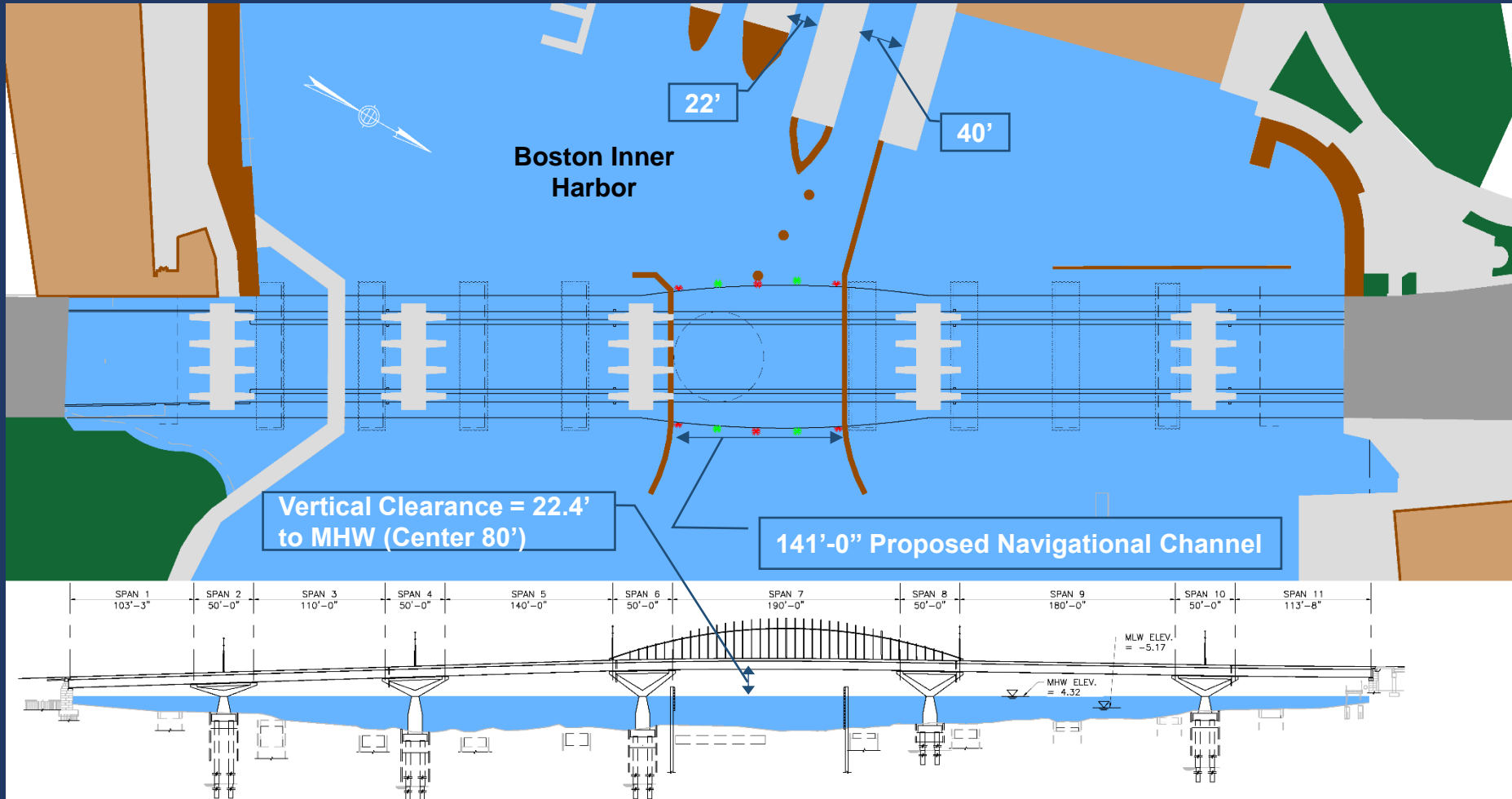

Proposed Fender System

Project Progress and Schedule

- Completed Conceptual Design: Spring 2015
- Preliminary Design: Fall 2015
- Environmental Permits: 2015 to 2016
- Final Design: Winter 2016
- Anticipated Construction Activity: 2017 to 2020



Contact

Chief Engineer:

Patricia A. Leavenworth, P.E.
Project File No. 604173

MassDOT- Highway Division
10 Park Plaza
Boston, MA 02116

Public Outreach:

Elizabeth Flanagan,
Public Involvement Specialist

Howard Stein Hudson
EFlanagan@hshassoc.com
617-482-7080



Thank you

Q & A

North Washington Street Bridge Replacement Project Boston, Massachusetts

