

KENSINGTON  
PANNING

TRADITIONAL  
HARDWARE

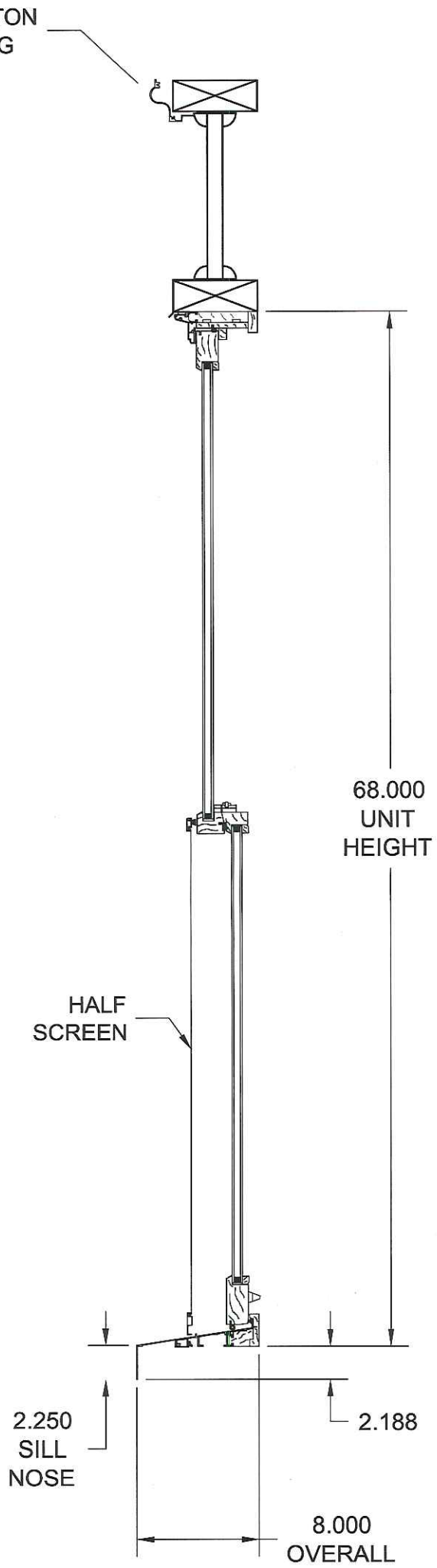

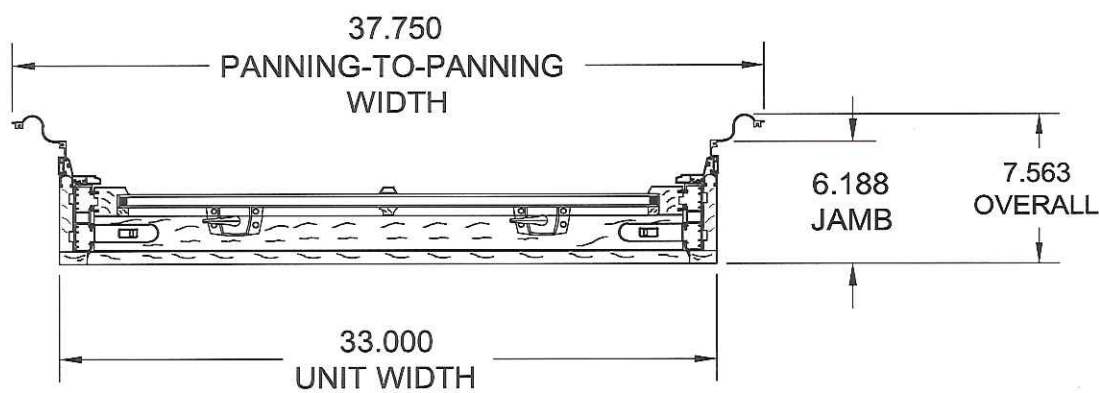

**PROJECT**

**MODERN**  
ARCHITECTURAL GLAZING  
WWW.MODERNGLAZING.COM

**DRAWING LIST**

C-1: COVER PAGE

SD-1:  
SD-2:  
SD-3:  
SD-4:  
SD-5:  
SD-6:  
SD-7:  
SD-8:  
SD-9:

SHEET:

**C-1**

**MCPHS University**  
**179 Longwood Avenue**  
**Boston, MA 02115**

SUBMISSION	DATE:
FABRICATION ISSUE	DATE: APPROVING SIGNATURE:

**SYSTEM/GENERAL NOTES:**

**SYMBOLS**

DR300 4-9/16" JAMB:  
WOOD INTERIOR / ALUMINUM CLAD EXTERIOR  
UNFINISHED OAK / AAMA 2603 BLACK

GLASS:  
CLIMAGUARD LOW-E ARGON FILLED INSULATED UNITS

HARDWARE:  
TILT LATCH (OIL RUBBED BRONZE) | FIBERGLASS HALF SCREENS

GRIDS:  
5/8" SDL SB OAK PATTERNS AS SHOWN

 = GLAZING TYPE

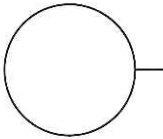
 = DETAIL PAGE REFERENCE

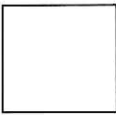
 = FRAME ID

PROJECT:	
TITLE	COVER SHEET
DATE: 05/09/18	SCALE:
DRAWN BY: Nate	CHECKED BY:

**MODERN**  
ARCHITECTURAL GLAZING  
12 BRUSSELS STREET  
WORCESTER, MA 01610  
TEL: 508.791.7151  
FAX: 508.792.0828

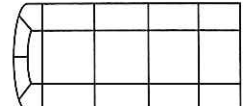

TYPE:

QTY: 2

SHEET:

SD-1

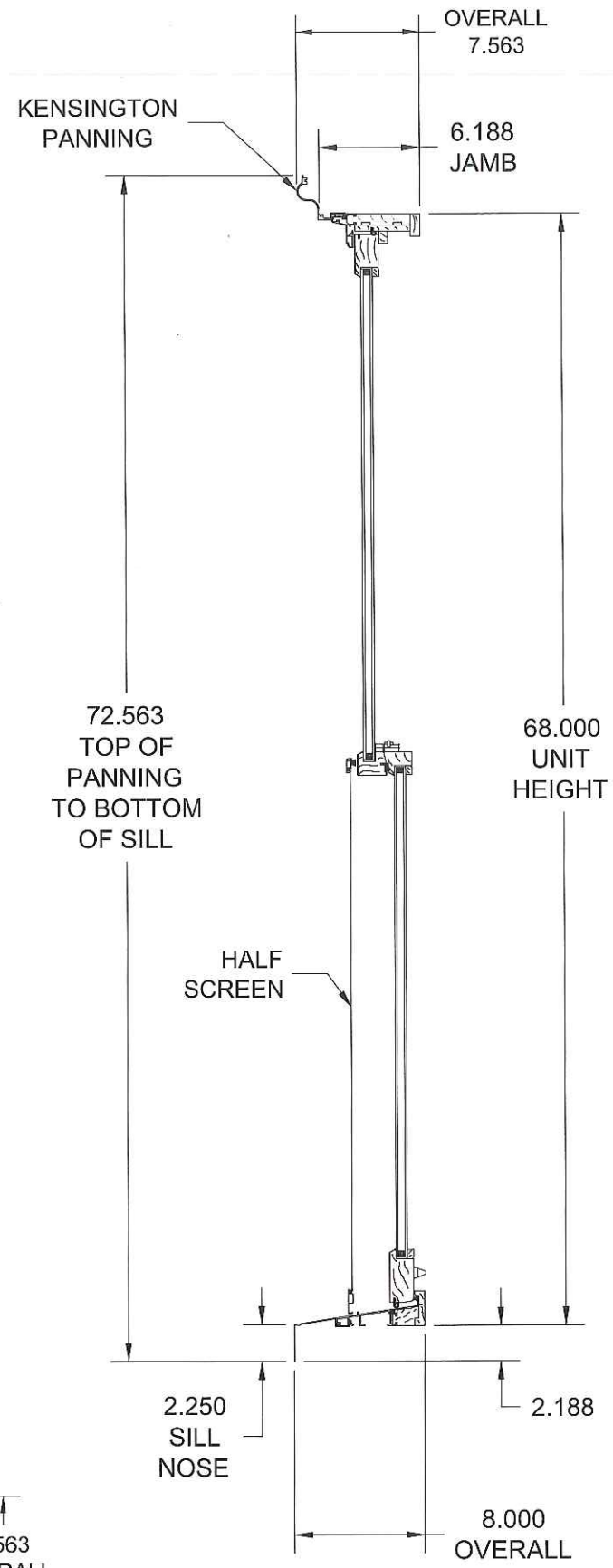
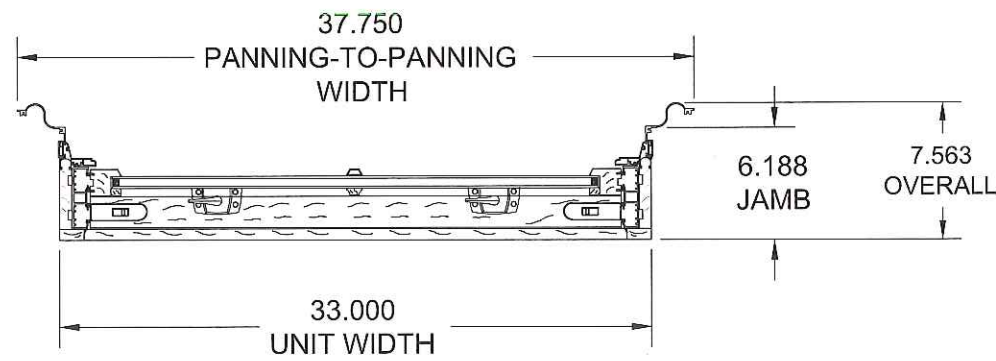
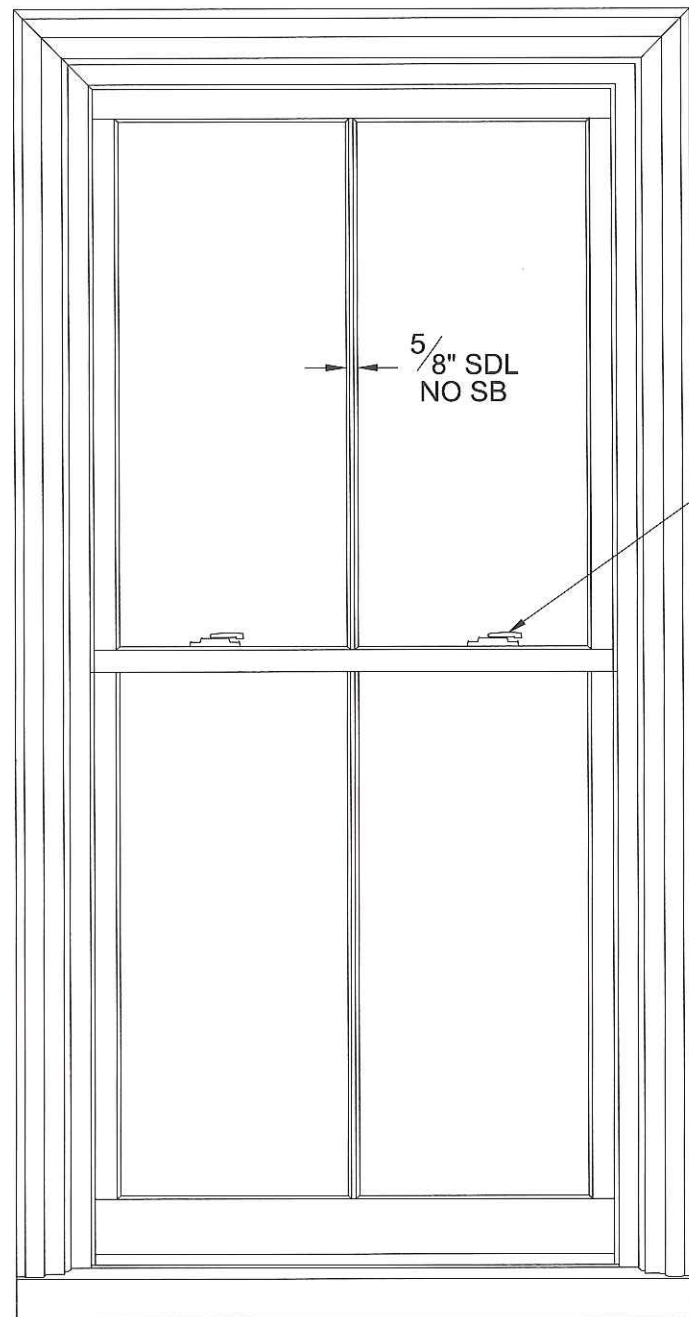

SUBMISSION	DATE:		FABRICATION ISSUE
	DATE:		
PROJECT:	MCPHS University Windows		
TITLE			
DATE:	05/09/18	SCALE:	N.T.S.
DRAWN BY:	Nate	CHECKED BY:	

**MODERN**  
 ARCHITECTURAL GLAZING  
 12 BRUSSELS STREET  
 WORCESTER, MA 01610  
 TEL: 508.791.7151  
 FAX: 508.792.0828

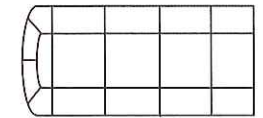

TYPE:

QTY: 2

SHEET:

**SD-2**

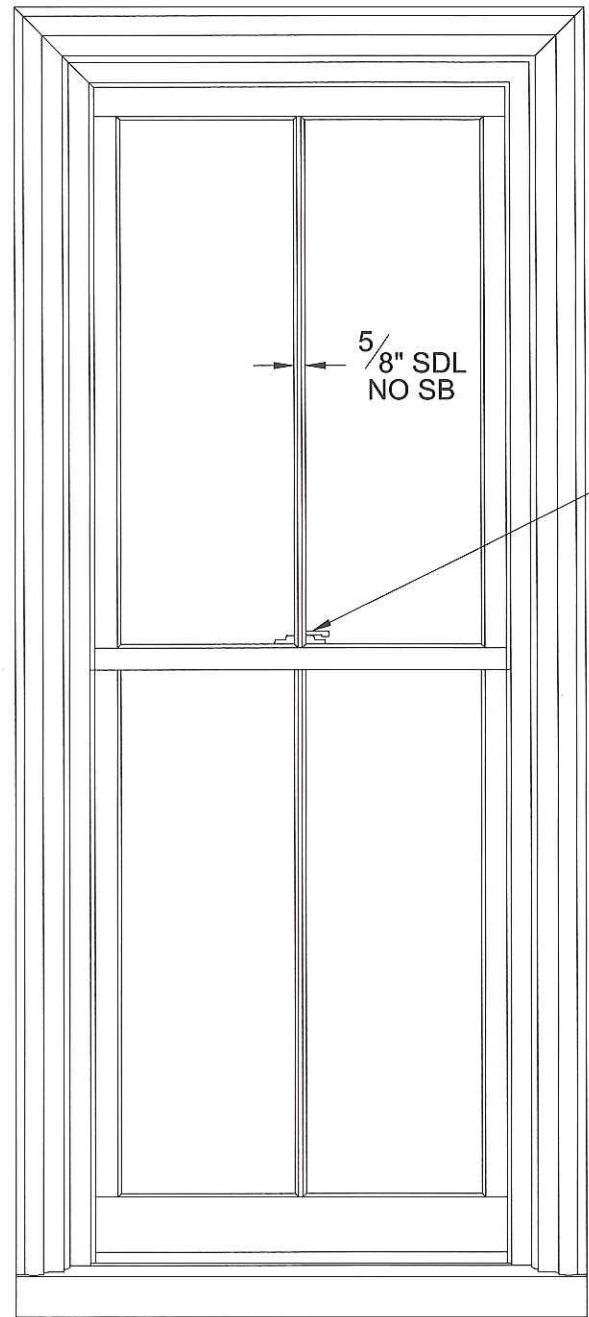

TRADITIONAL  
HARDWARE

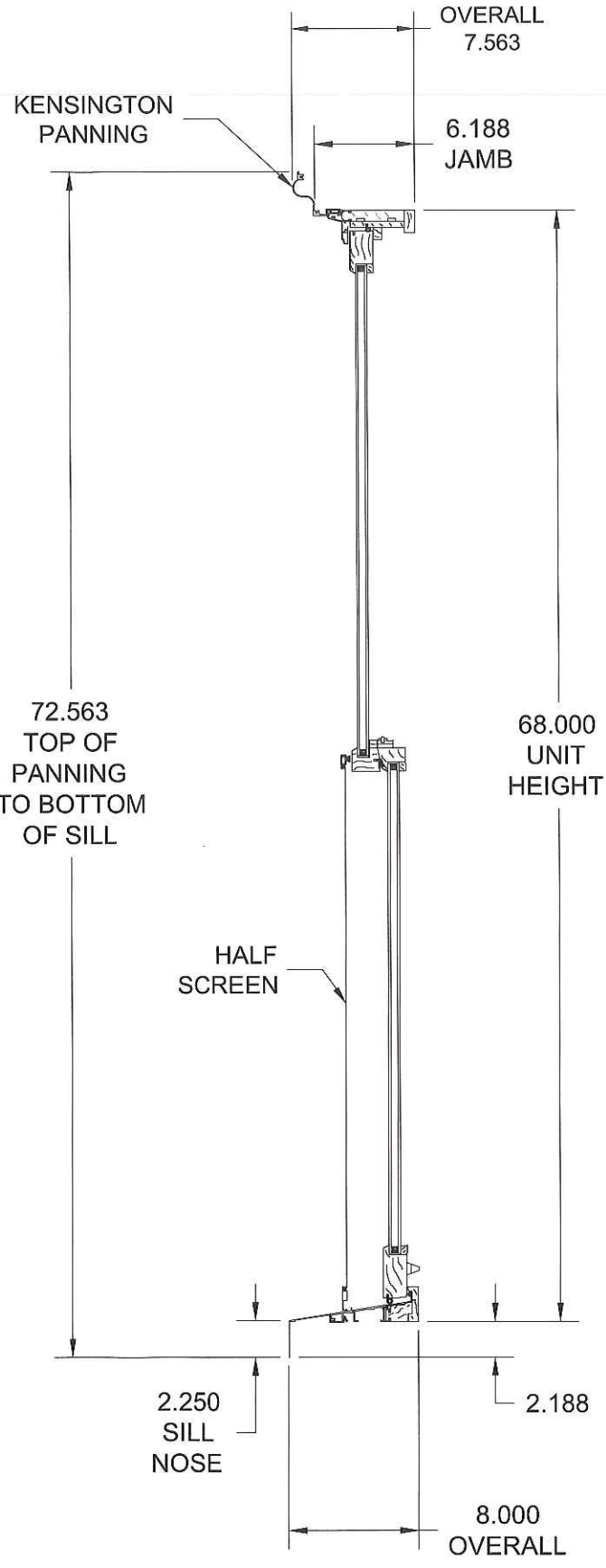
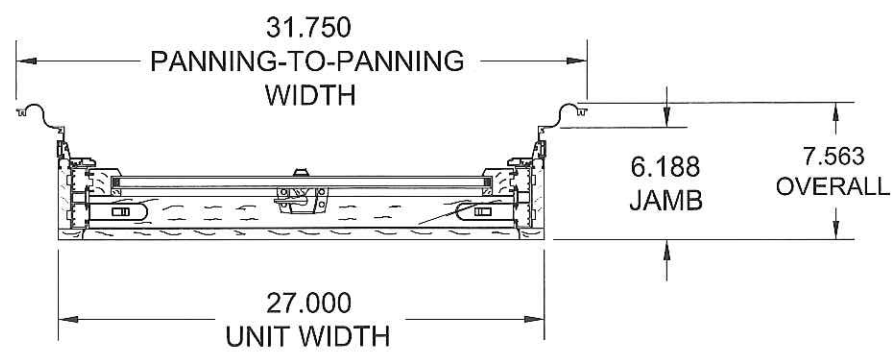

SUBMISSION	DATE:	FABRICATION ISSUE
	DATE:	
PROJECT: MCPHS University Windows		
TITLE		
DATE: 05/09/18	SCALE: N.T.S.	CHECKED BY:
DRAWN BY: Nate		

**MODERN**  
 ARCHITECTURAL GLAZING  
 12 BRUSSELS STREET  
 WORCESTER, MA 01610  
 TEL: 508.791.7151  
 FAX: 508.792.0828

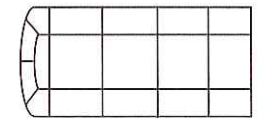



TYPE:

QTY: 4

SHEET:

**SD-3**

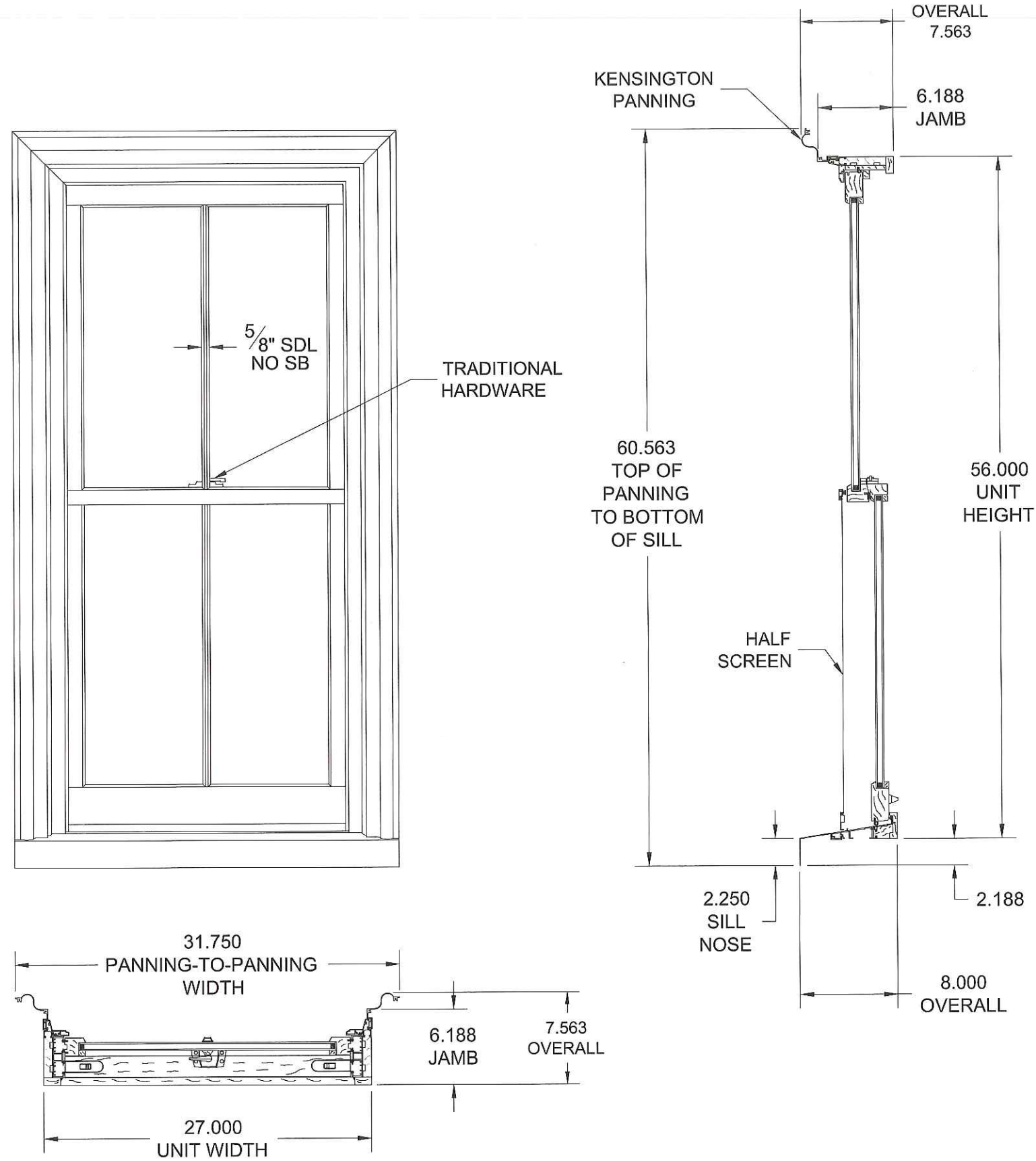

SUBMISSION	DATE:	FABRICATION ISSUE
	DATE:	
PROJECT:	MCPHS University Windows	CHECKED BY:
TITLE		Nate
DATE:	05/09/18	SCALE:
DRAWN BY:		N.T.S.

**MODERN**  
 ARCHITECTURAL GLAZING  
 12 BRUSSELS STREET  
 WORCESTER, MA 01610  
 TEL: 508.791.7151  
 FAX: 508.792.0828

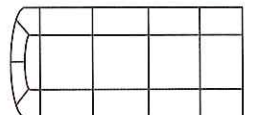

TYPE:

QTY: 3

SHEET:

**SD-4**

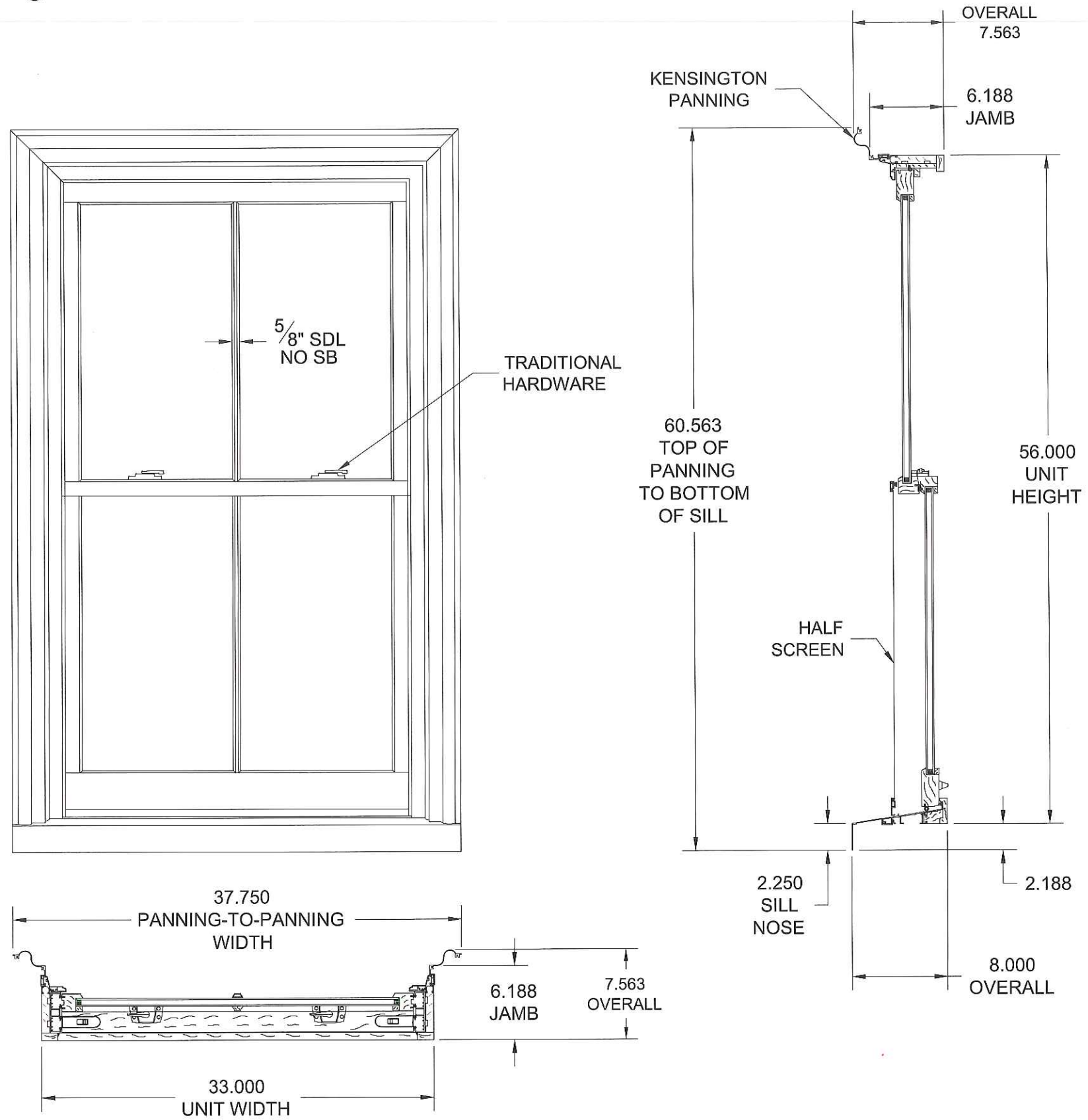

SUBMISSION	DATE:	FABRICATION ISSUE
	DATE:	
PROJECT:	MCPHS University Windows	CHECKED BY:
TITLE		Nate
DATE:	05/09/18	SCALE: N.T.S.
DRAWN BY:		CHECKED BY:

**MODERN**  
ARCHITECTURAL GLAZING  
12 BRUSSELS STREET  
WORCESTER, MA 01610  
TEL:508.791.7151  
FAX:508.792.0828

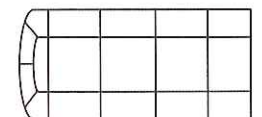





TYPE:

QTY: 3

SHEET:

# SD-6

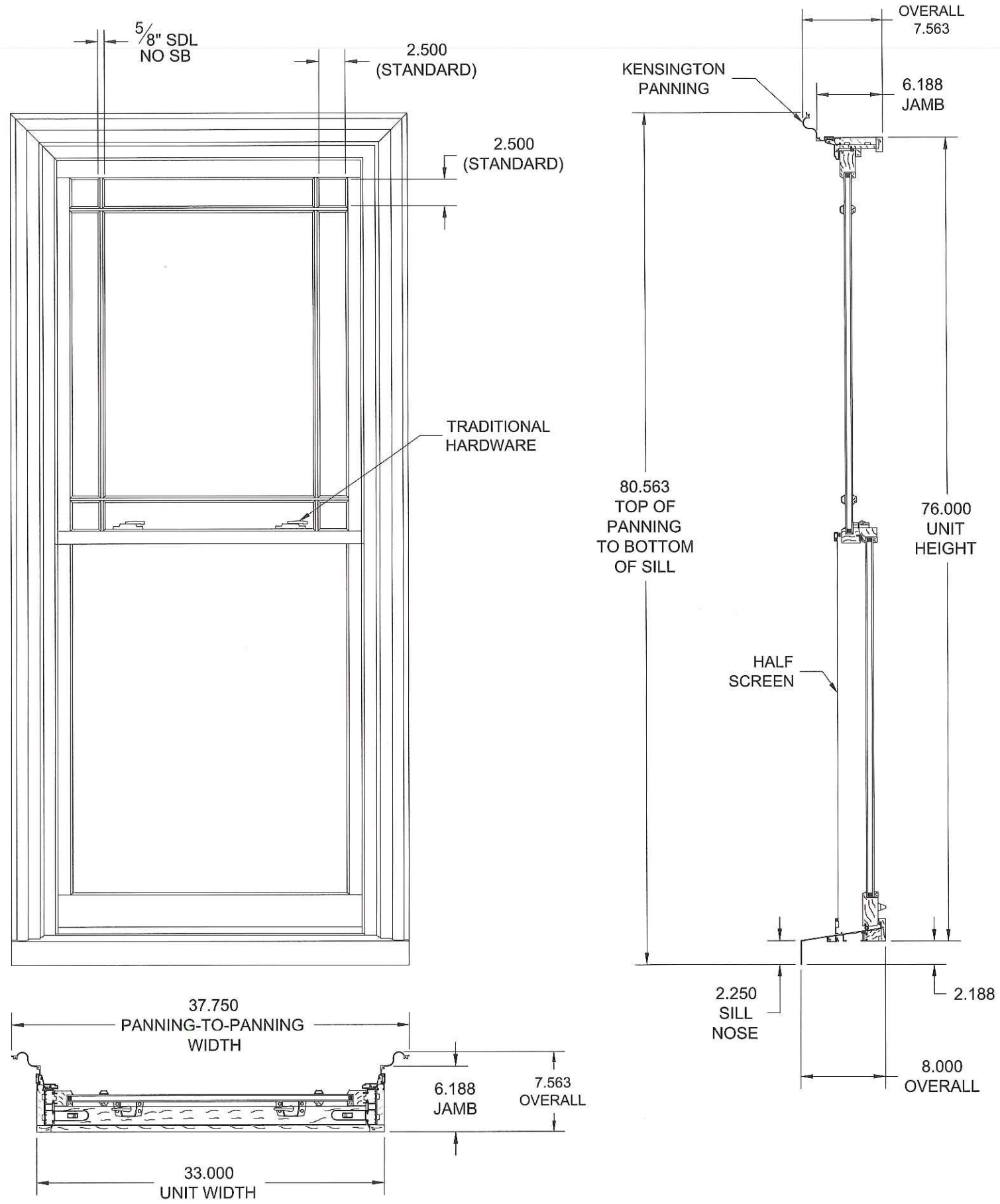

SUBMISSION	DATE:	FABRICATION ISSUE
	DATE:	
PROJECT: MCPHS University Windows		
TITLE		
DATE: 05/09/18	SCALE: N.T.S.	CHECKED BY:
DRAWN BY: Nate		

**MODERN**  
ARCHITECTURAL GLAZING  
12 BRUSSELS STREET  
WORCESTER, MA 01610  
TEL: 508.791.7151  
FAX: 508.792.0828

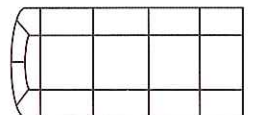





1. North elevation windows

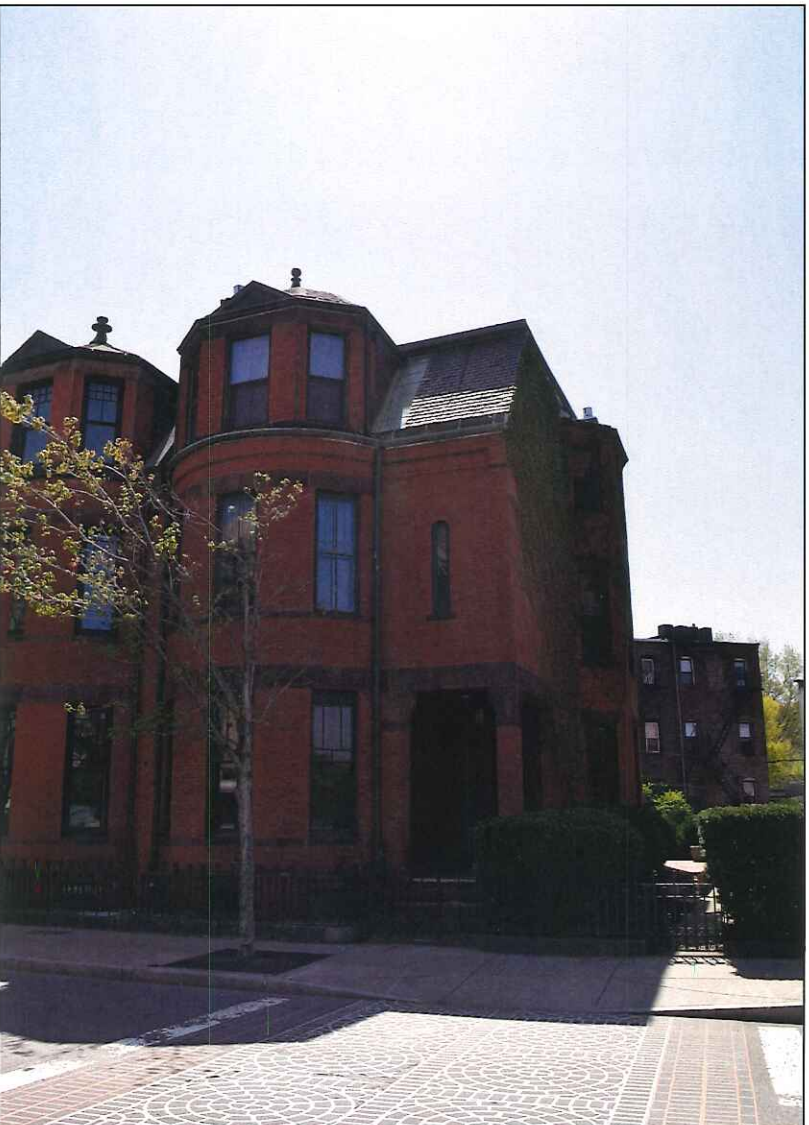

2. North elevation windows







3. North elevation, basement, window 1



4. North elevation, basement, window 1





5. North elevation, basement, window 2



6. North elevation, basement, window 2





7. North elevation, basement, window 3



8. North elevation, basement, window 3





9. North elevation, first floor, window 4

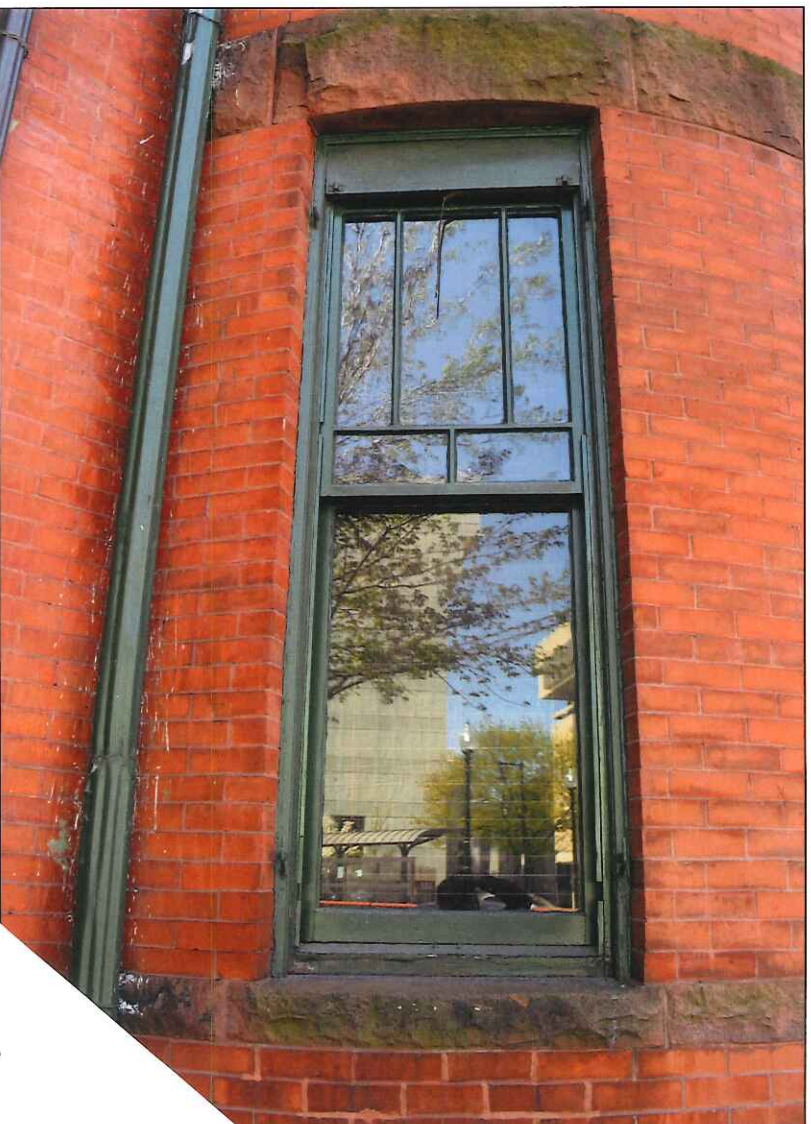

10. North elevation, first floor, window 4





11. North elevation, first floor, window 5

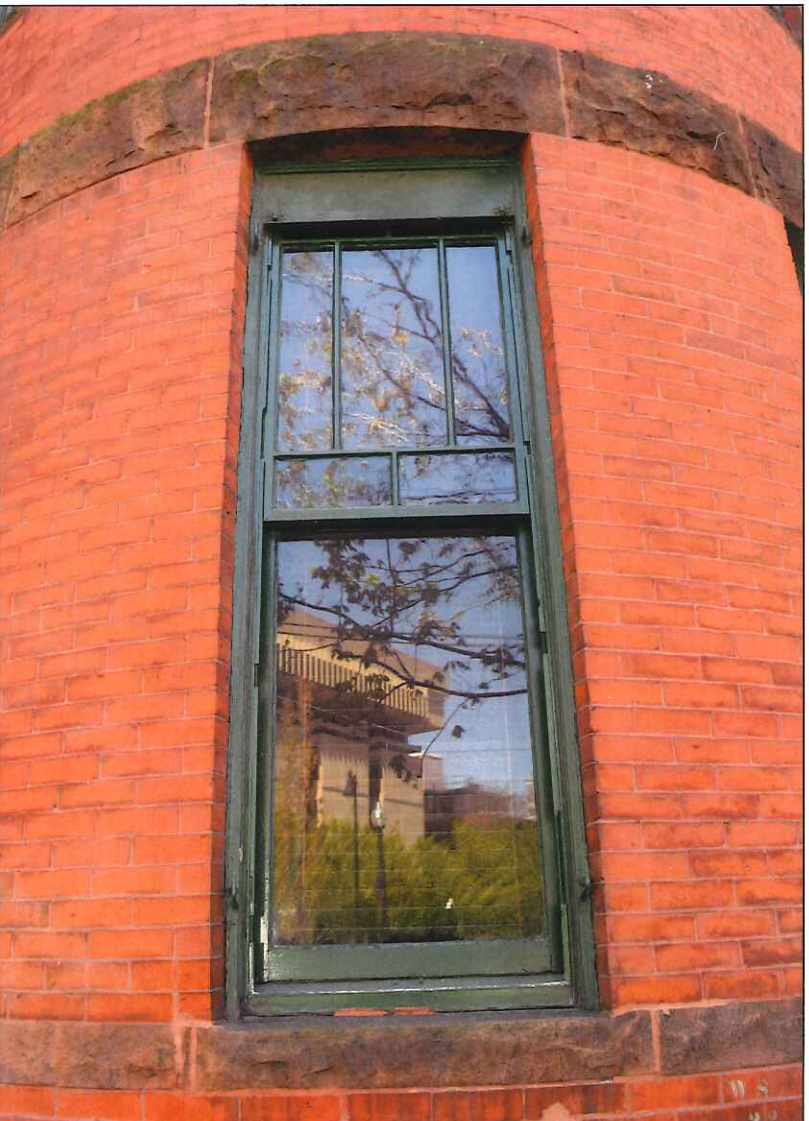

12. North elevation, first floor, window 5







13. North elevation, first floor, window 6



14. North elevation, first floor, window 6







15. North elevation, second floor, window 7



16. North elevation, second floor, window 7

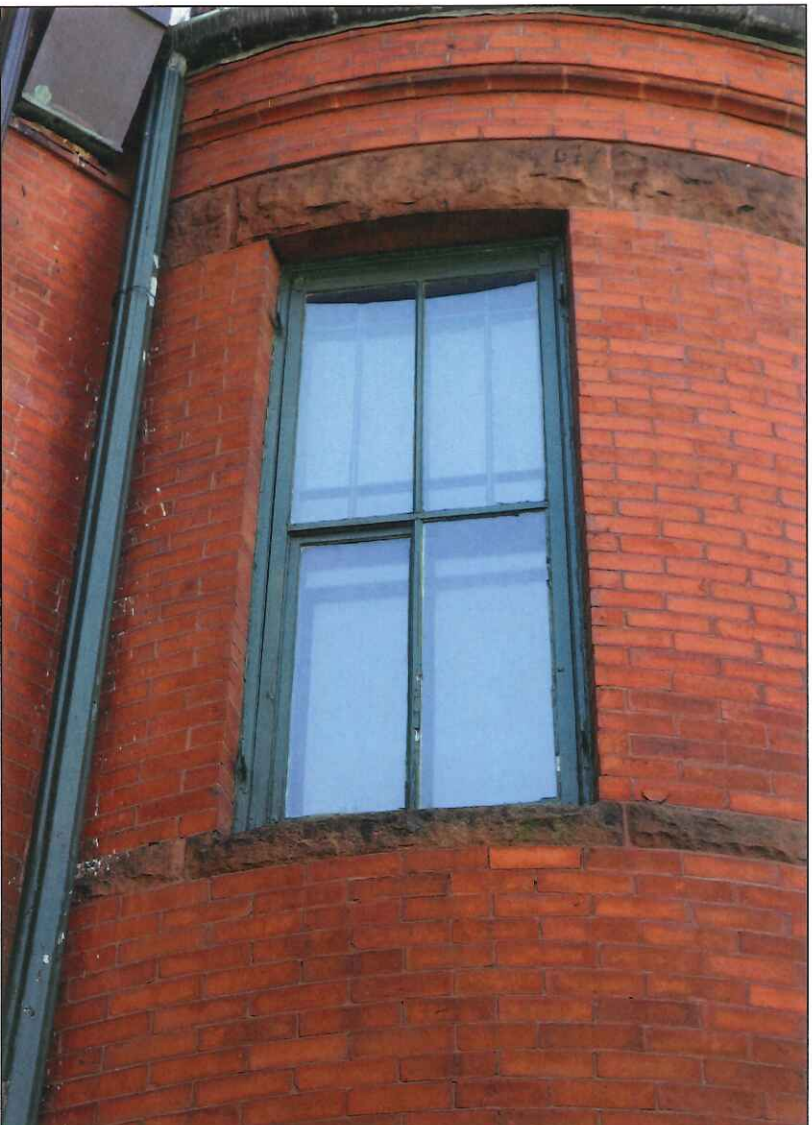

17. North elevation, second floor, window 7

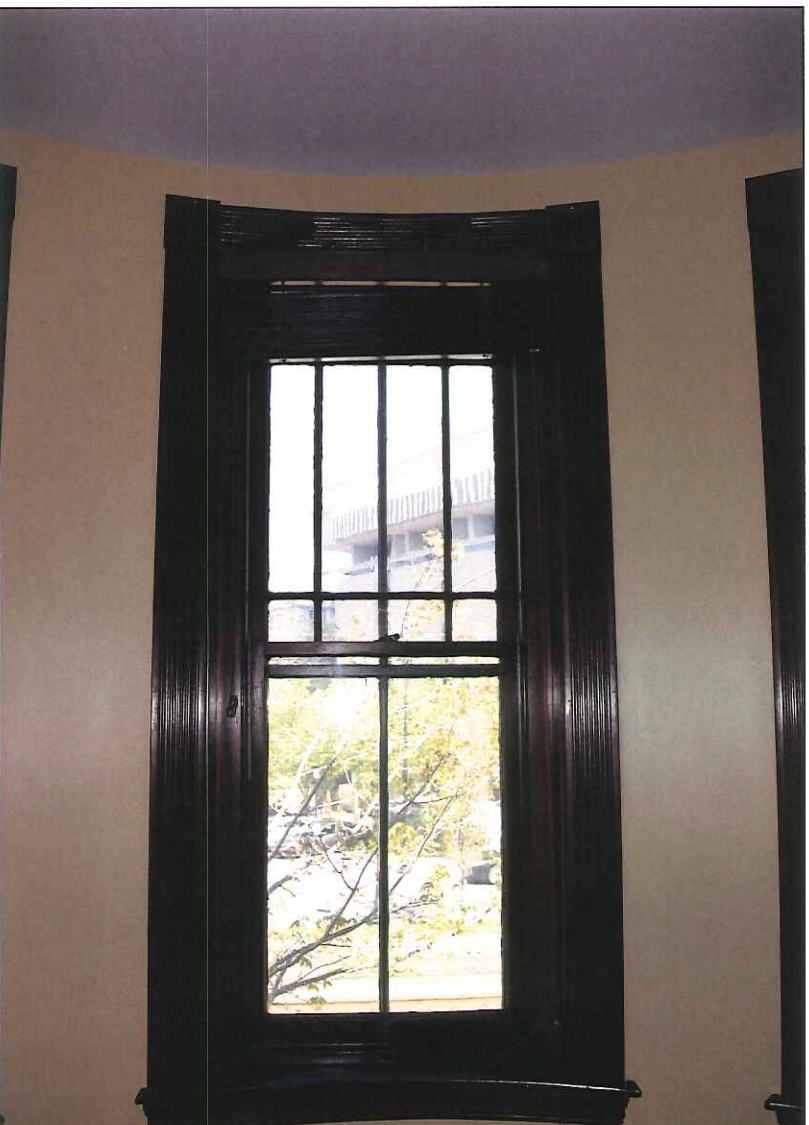

18. North elevation, second floor, window 8



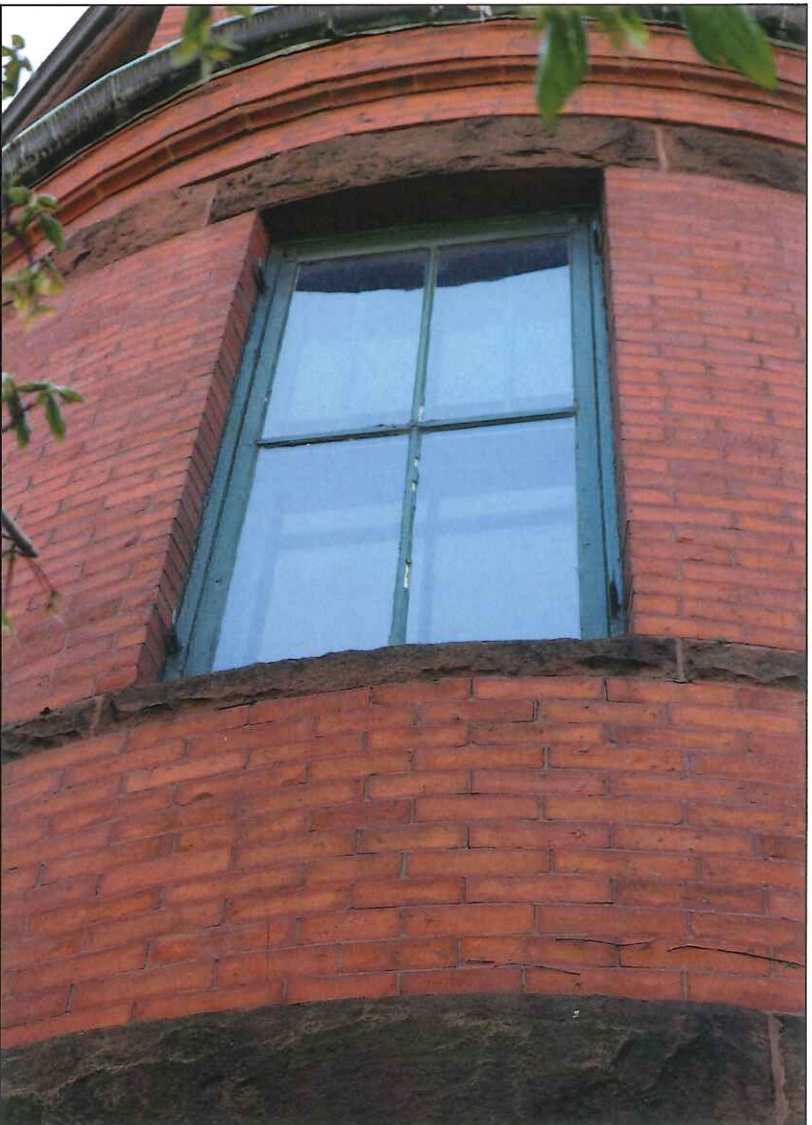

19. North elevation, second floor, window 8



20. North elevation, second floor, window 9



21. North elevation, second floor, window 9



22. North elevation, second floor, window 9







23. North elevation, second floor, window 10



24. North elevation, second floor, window 10





25. North elevation, third floor, windows 11-13



26. North elevation, third floor, windows 11-13



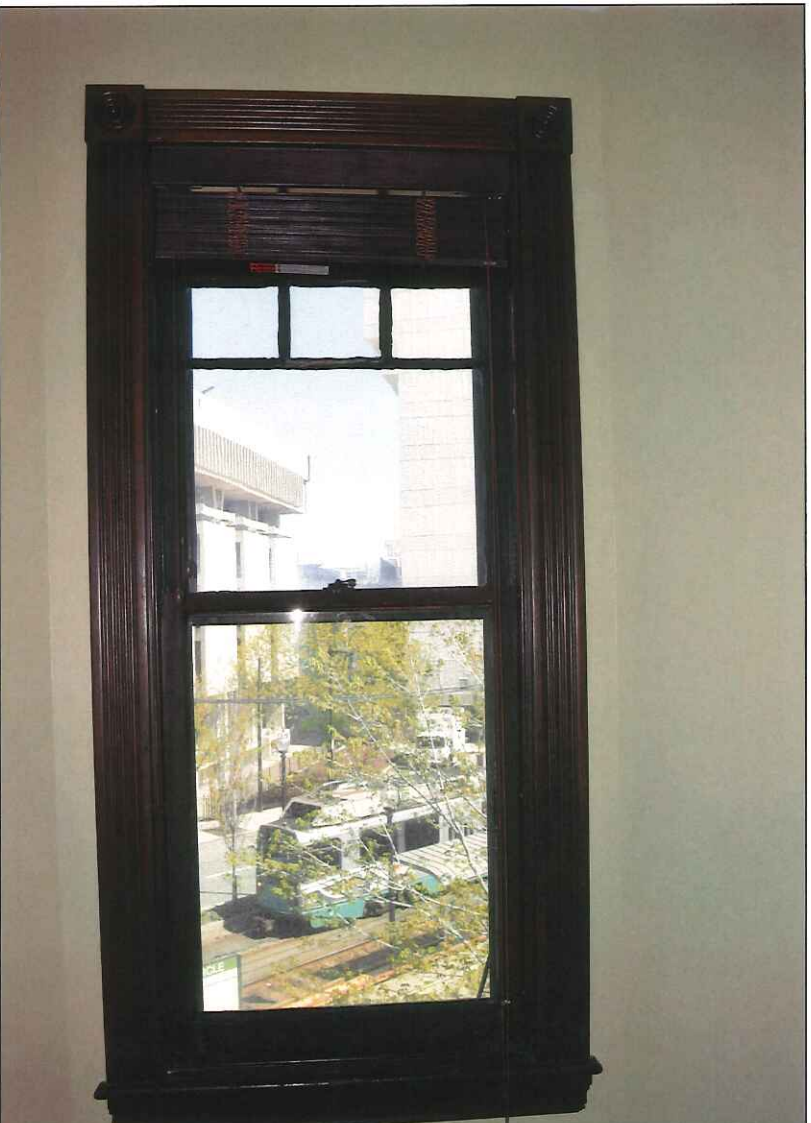

27. North elevation, third floor, window 11



28. North elevation, third floor, window 11





29. North elevation, third floor, window 12

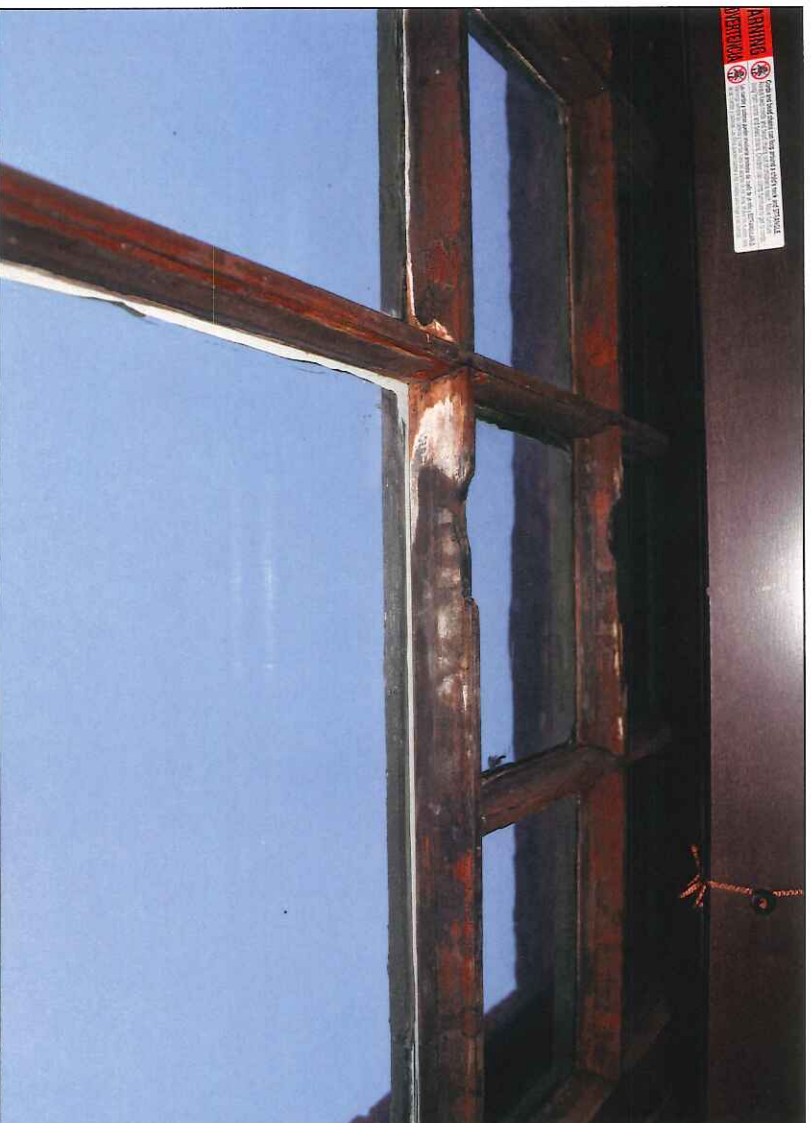

30. North elevation, third floor, window 12





31. North elevation, third floor, window 13



32. North elevation, third floor, window 13



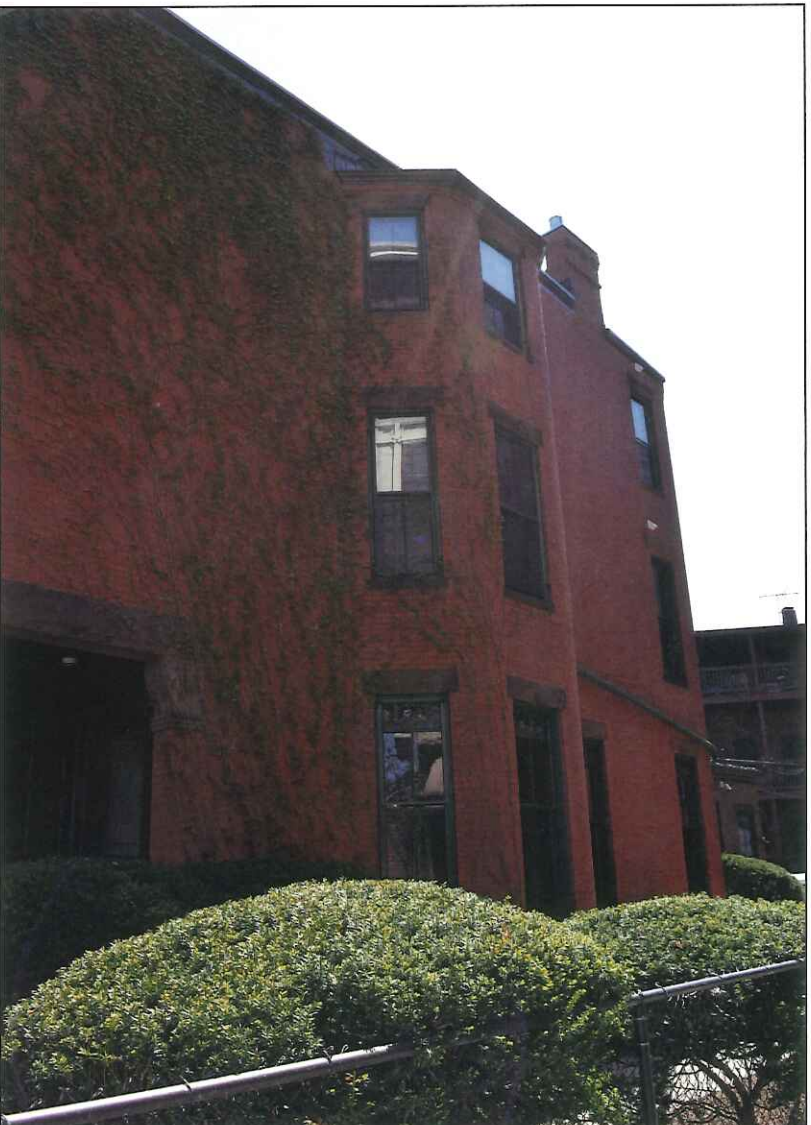

33. East elevation windows

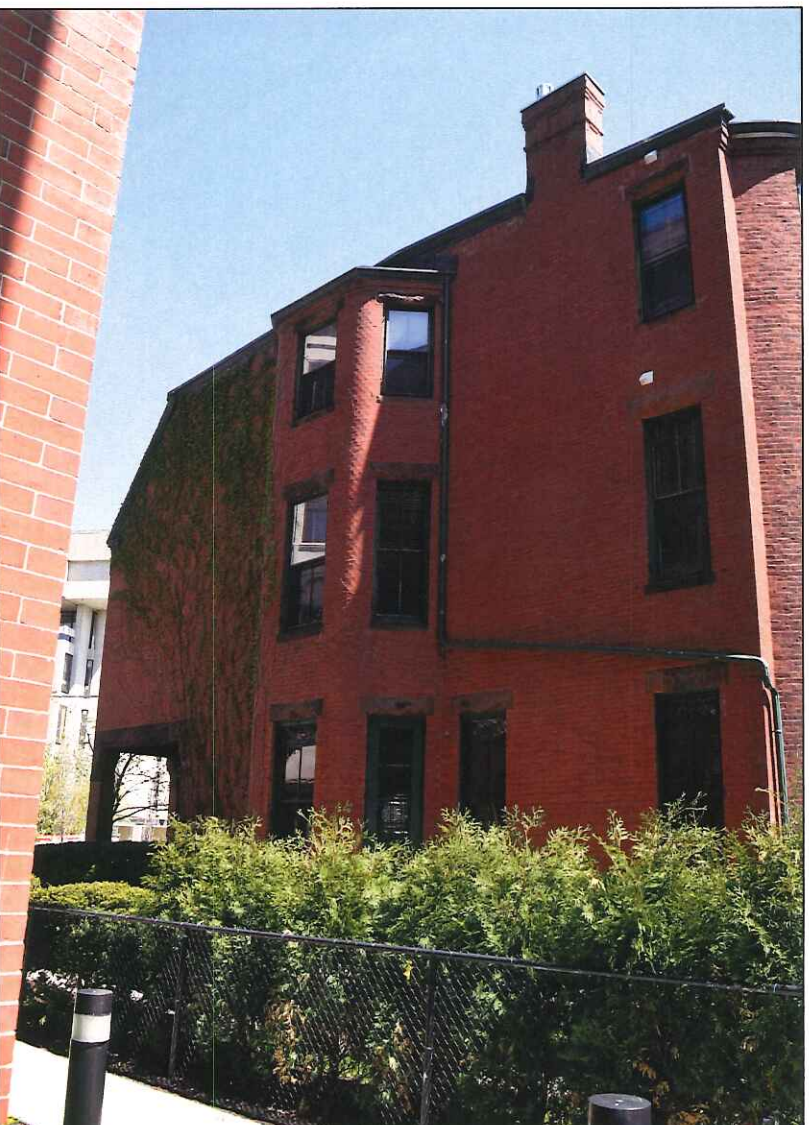

34. East elevation windows



Machosie Historic Advisors  
Bringing strategy, equity, and experience  
to historic building development





35. East elevation, basement, window 14



36. East elevation, basement, window 14





37. East elevation, basement, window 15



38. East elevation, basement, window 15





39. East elevation, basement, window 16



40. East elevation, basement, window 16





41. East elevation, basement, window 17



42. East elevation, basement, window 17





43. East elevation, first floor, window 18



44. East elevation, first floor, window 18



45. East elevation, first floor, window 18



46. East elevation, first floor, window 19





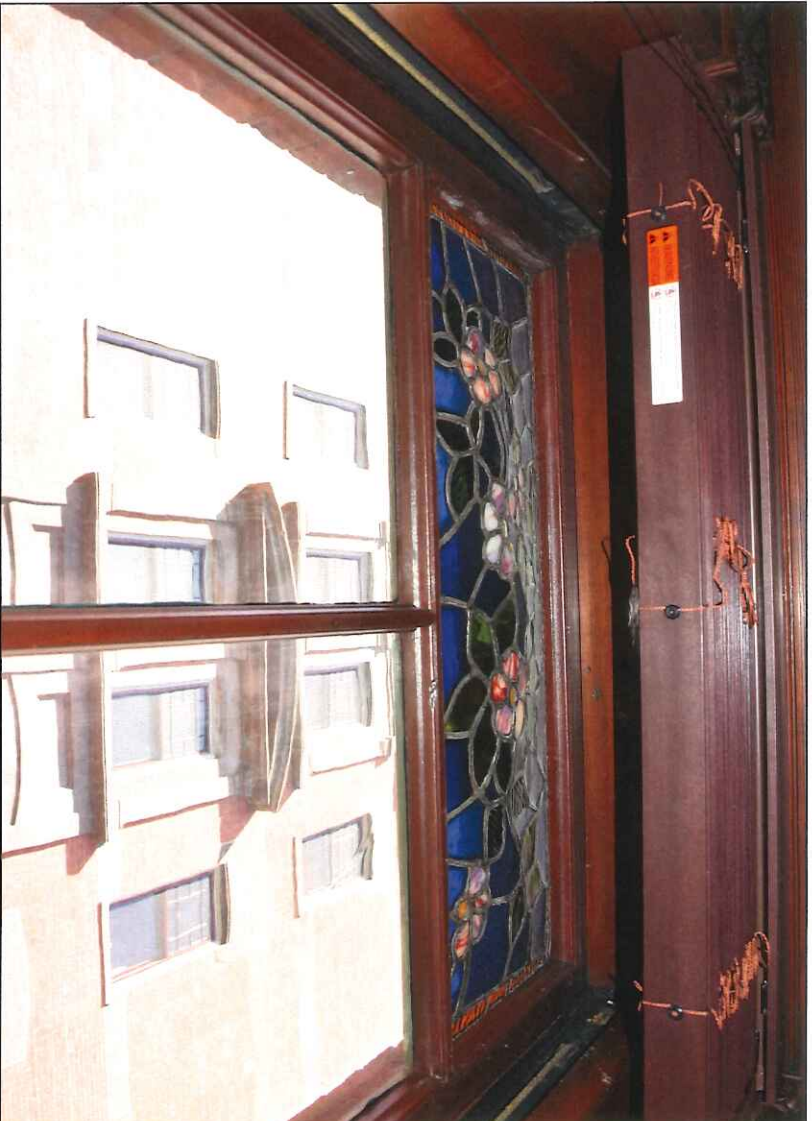

47. East elevation, first floor, window 19



48. East elevation, first floor, window 19



49. East elevation, first floor, window 20



50. East elevation, first floor, window 20





51. East elevation, first floor, window 20



52. East elevation, first floor, window 21

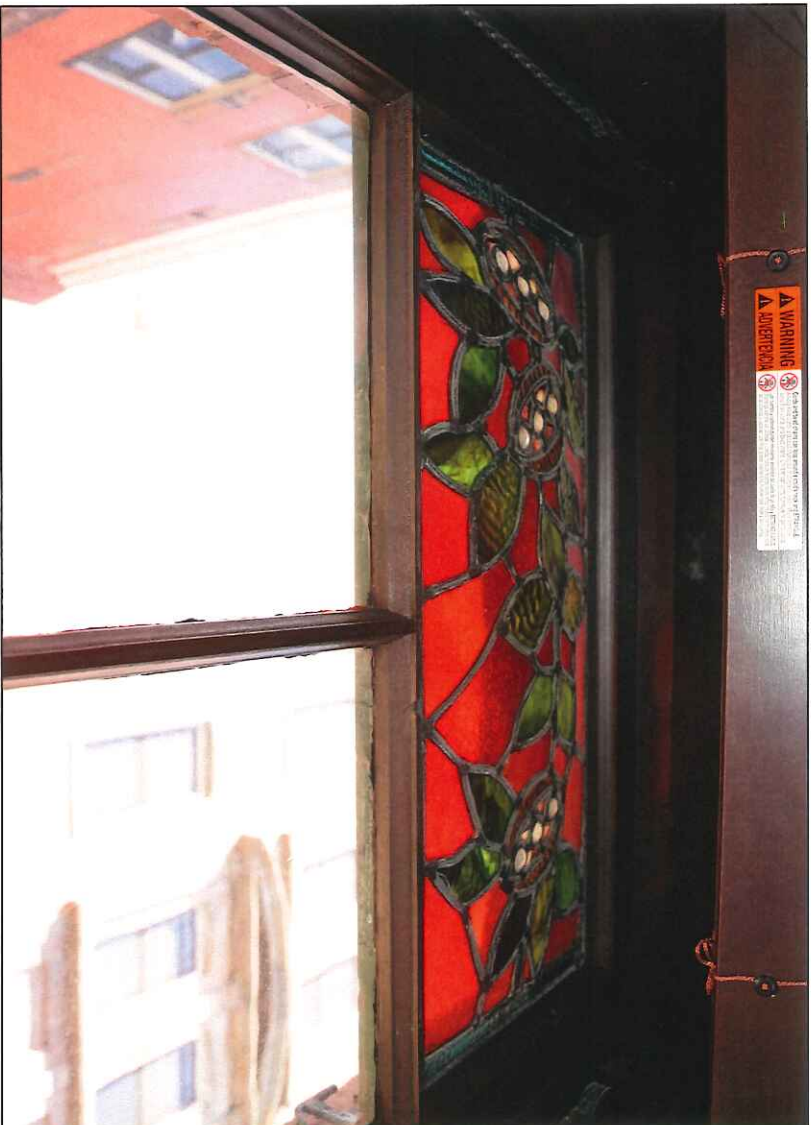

53. East elevation, first floor, window 21



54. East elevation, first floor, window 21







55. East elevation, first floor, windows 22/23



56. East elevation, first floor, windows 22/23





57. East elevation, second floor, window 24

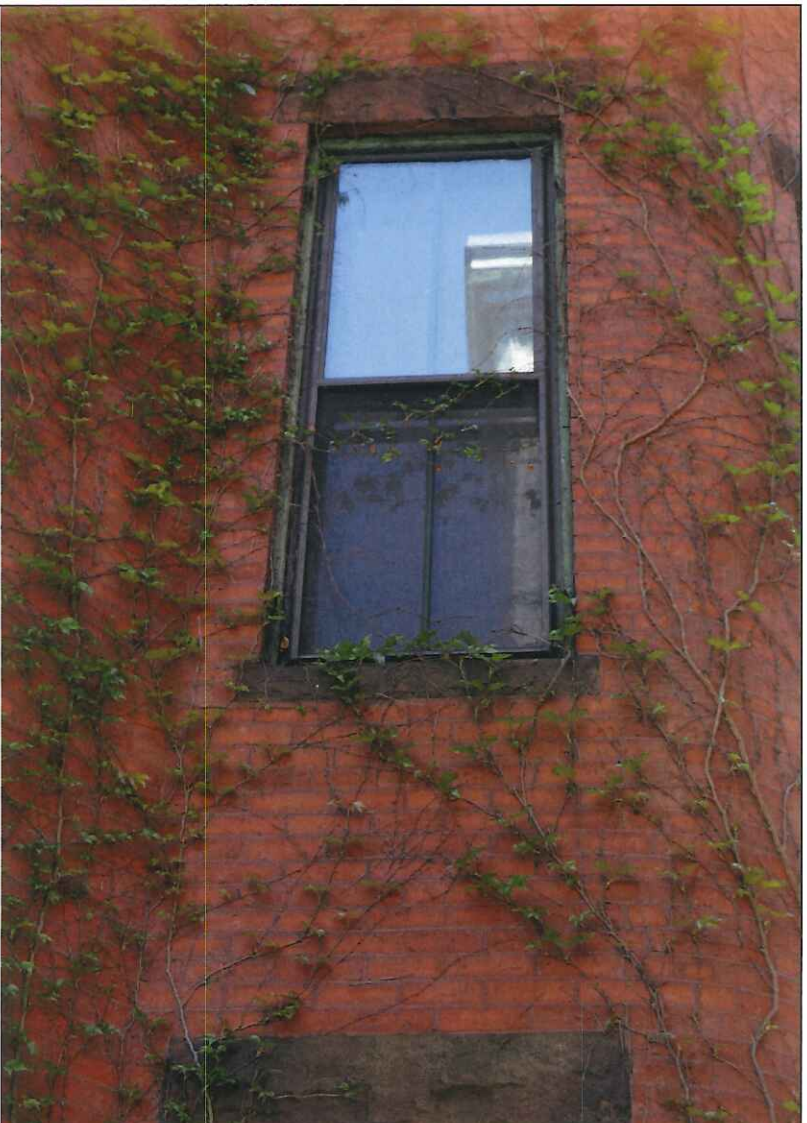

58. East elevation, second floor, window 24





59. East elevation, second floor, window 25



60. East elevation, second floor, window 25





61. East elevation, second floor, window 26



62. East elevation, second floor, window 26







63. East elevation, second floor, window 27

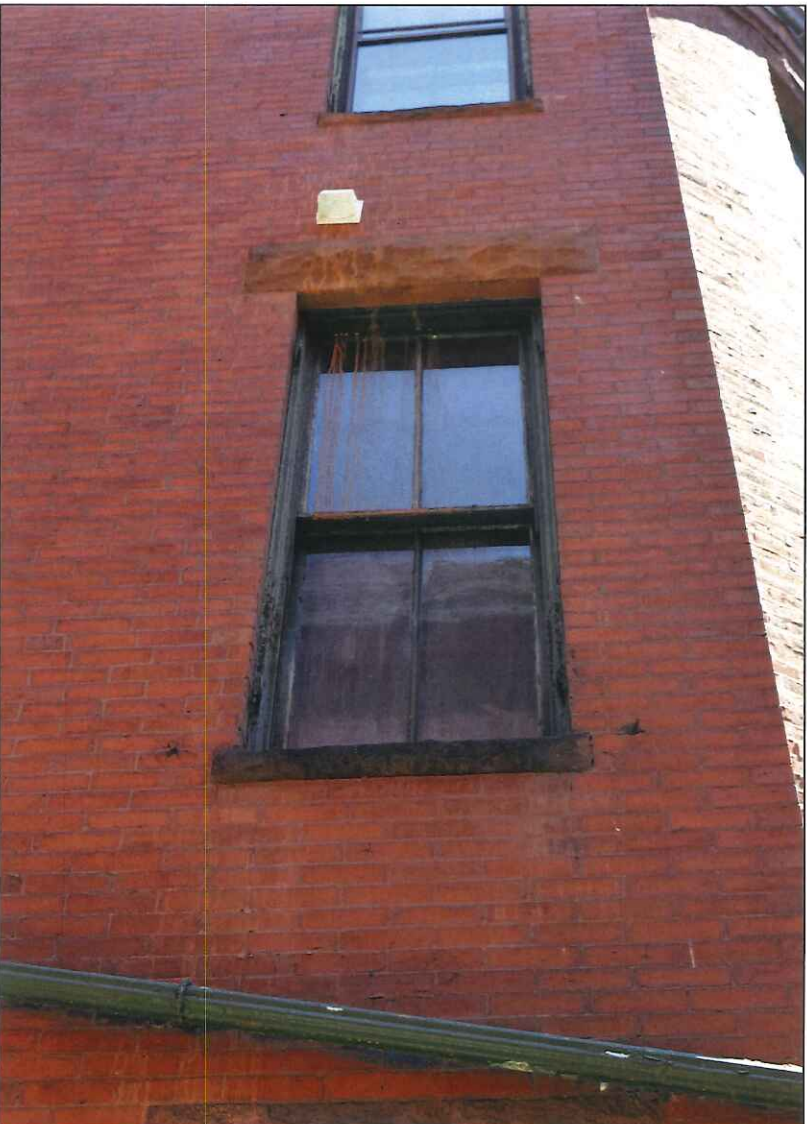

64. East elevation, second floor, window 27

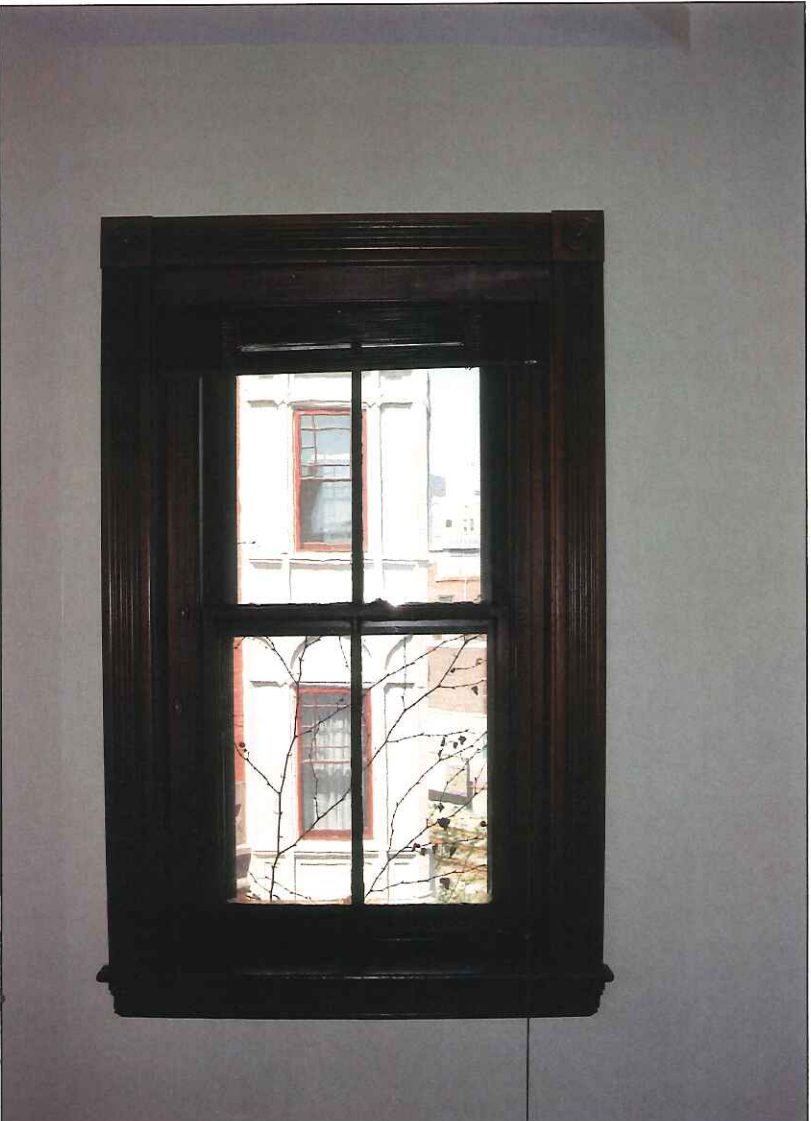

65. East elevation, third floor, window 28

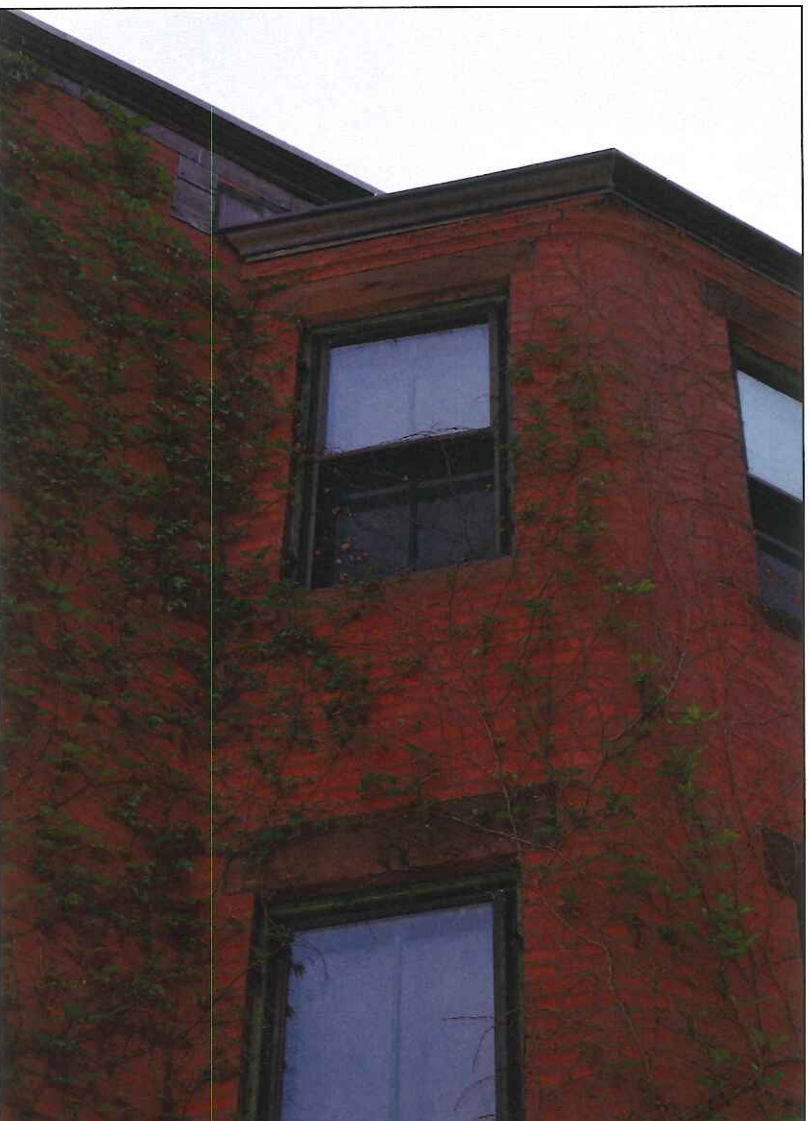

66. East elevation, third floor, window 28







67. East elevation, third floor, window 29

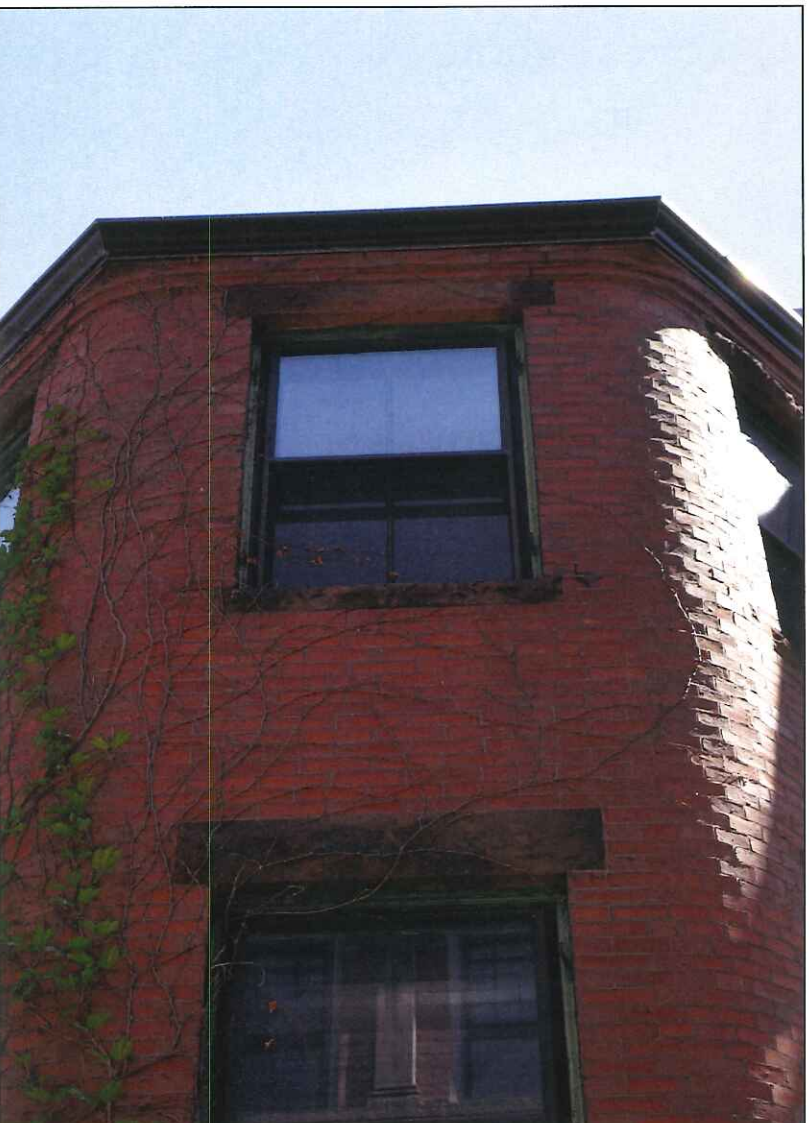

68. East elevation, third floor, window 29





69. East elevation, third floor, window 30



70. East elevation, third floor, window 30





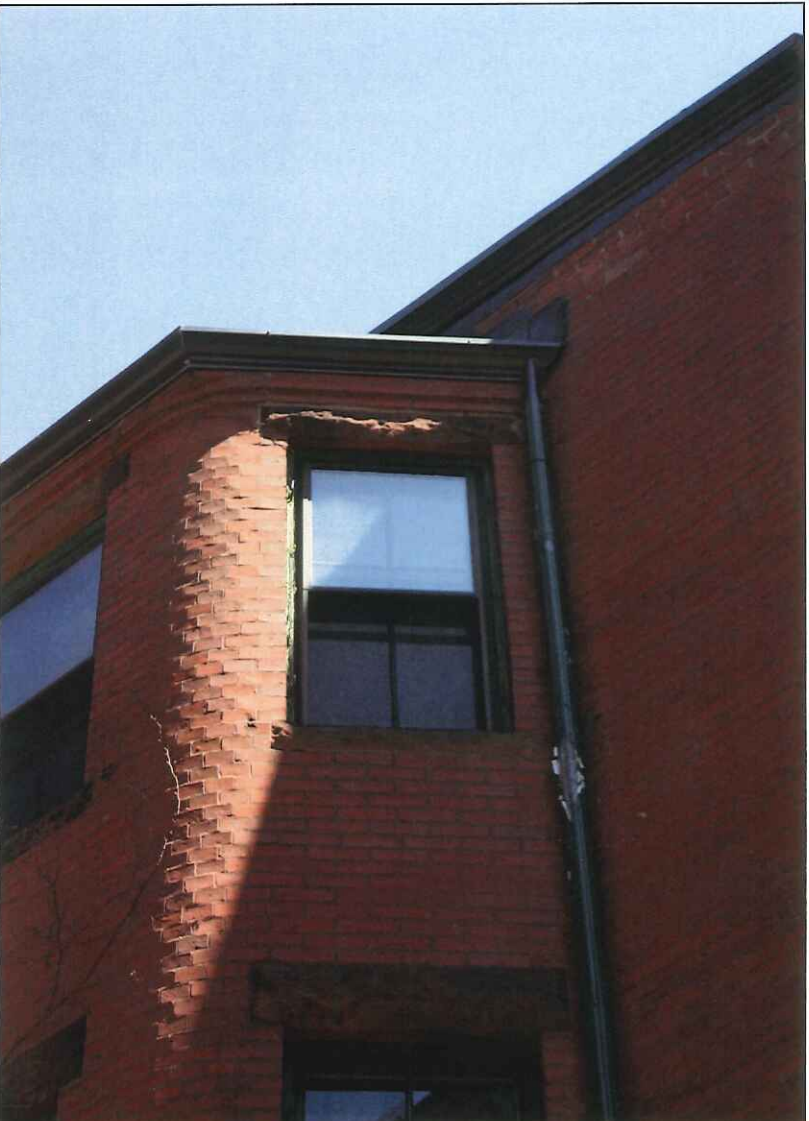

71. East elevation, third floor, window 30

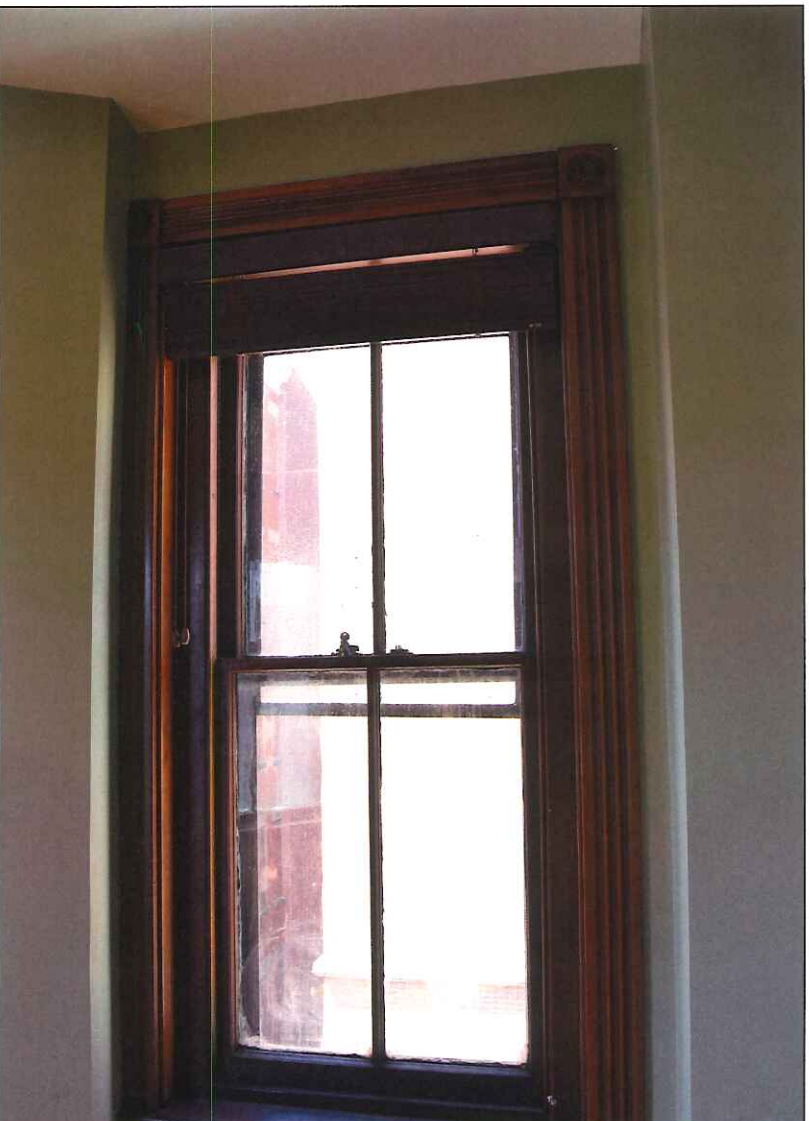

72. East elevation, third floor, window 31



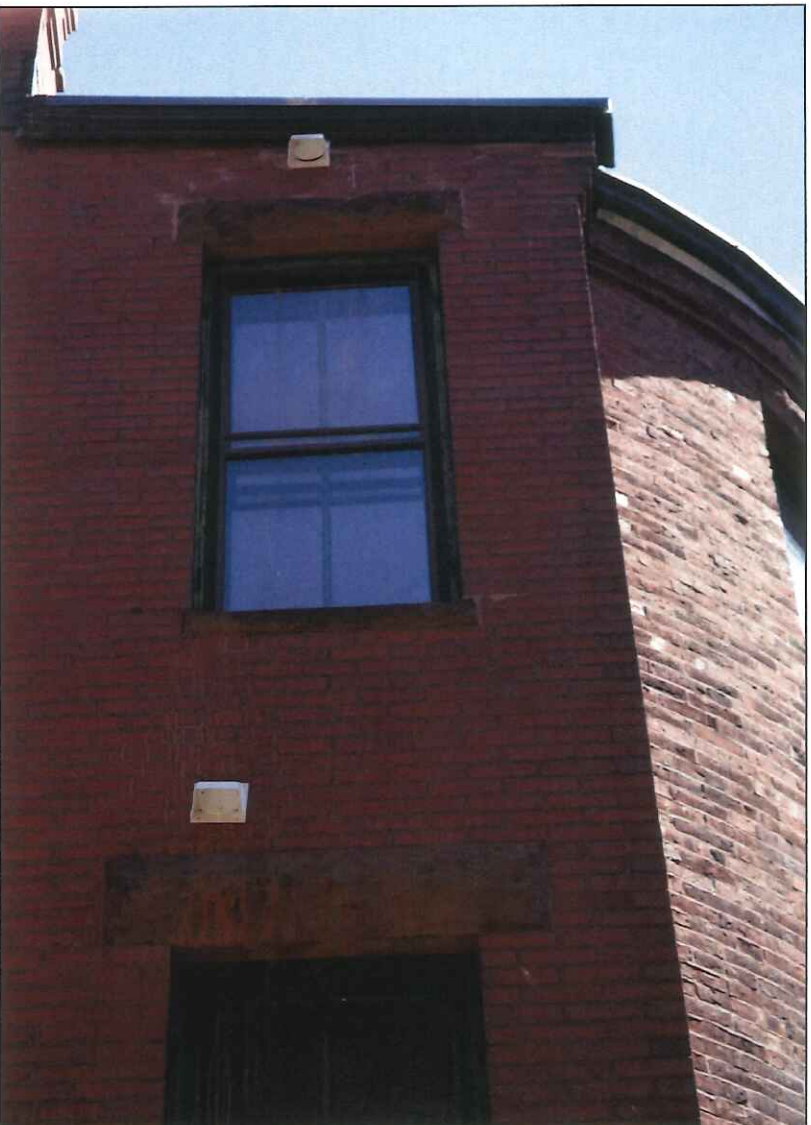

73. East elevation, third floor, window 31



74. South elevation windows





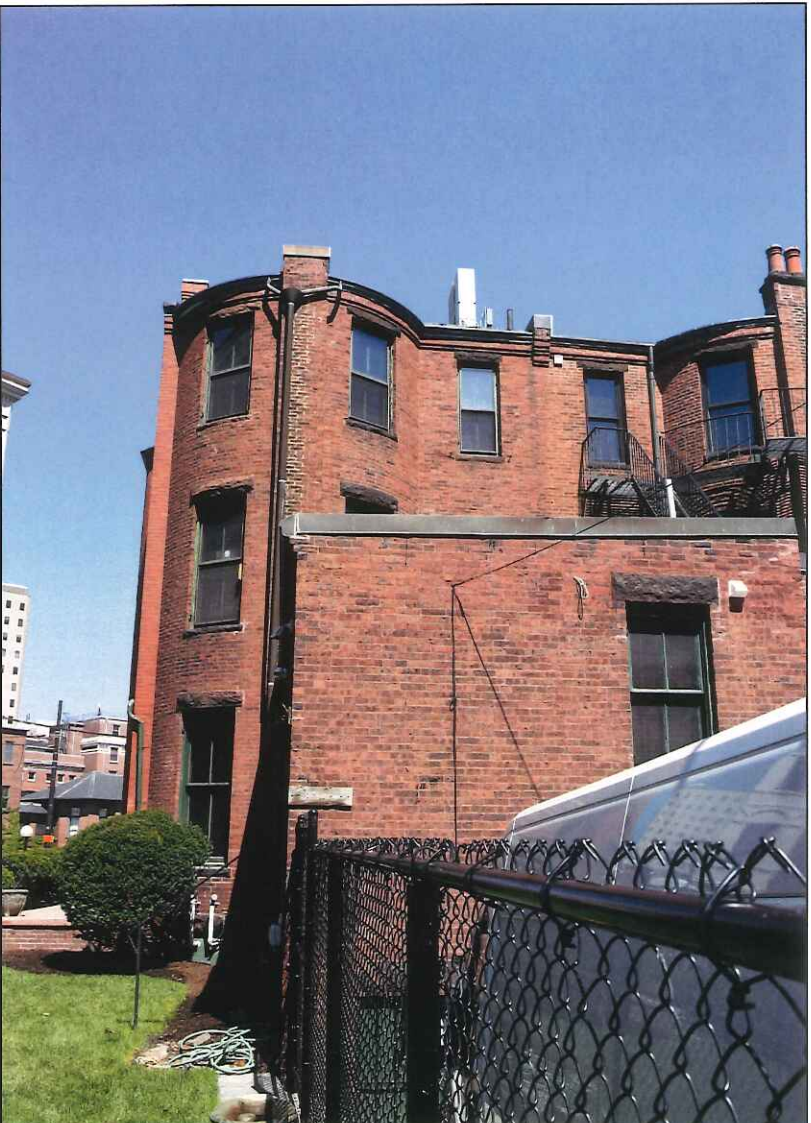

75. South elevation, basement, window 32







76. South elevation, basement, window 32



77. South elevation, basement, window 33





78. South elevation, basement, window 33



79. South elevation, basement, window 34



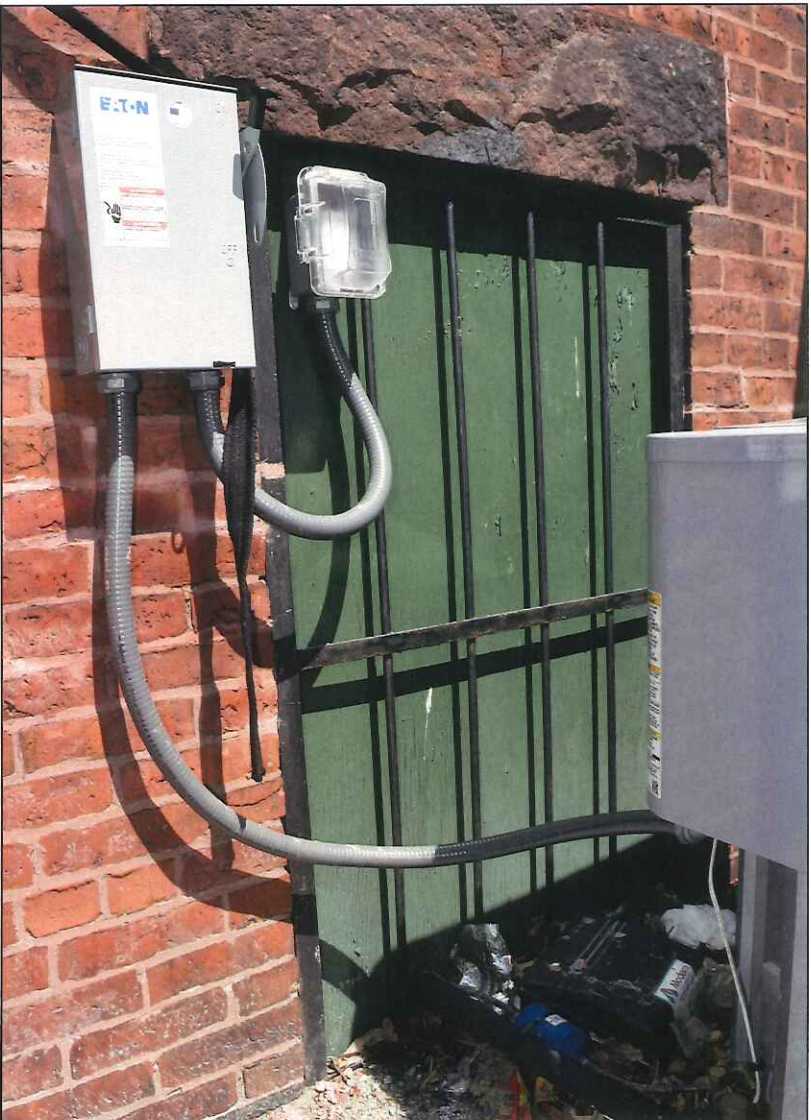

80. South elevation, basement, window 34

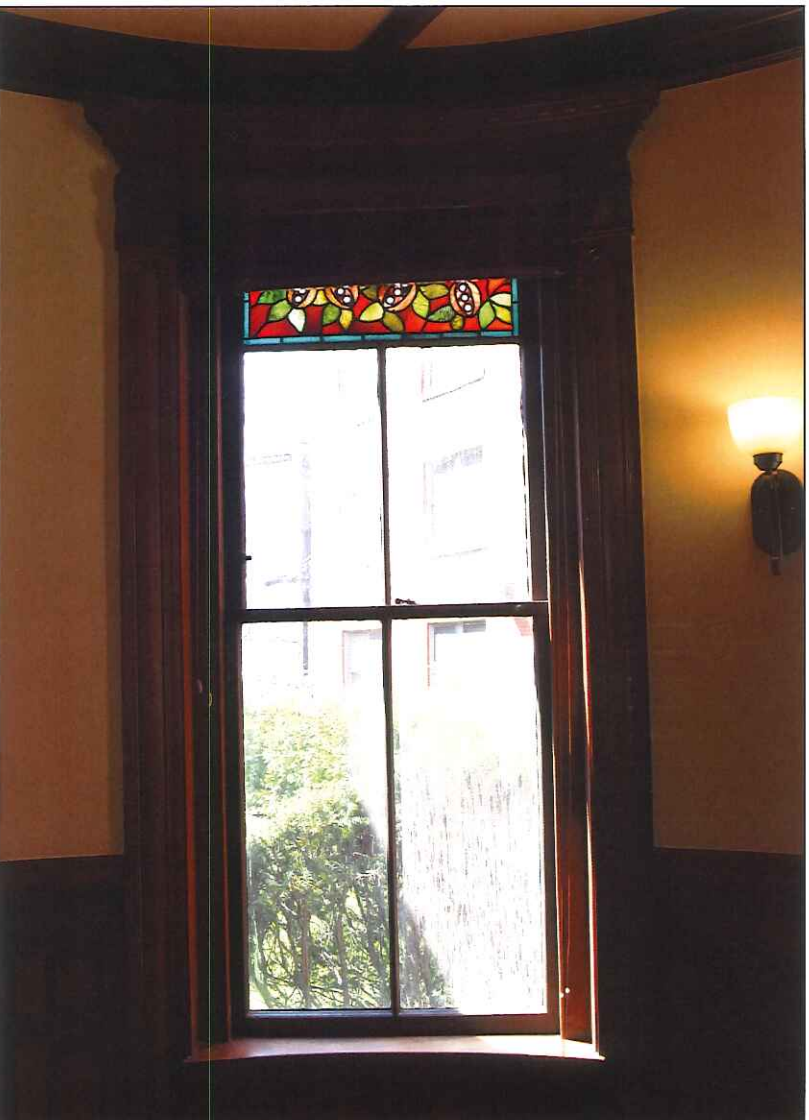

81. South elevation, first floor, window 35







82. South elevation, first floor, window 35



83. South elevation, first floor, window 35







84. South elevation, first floor, window 36

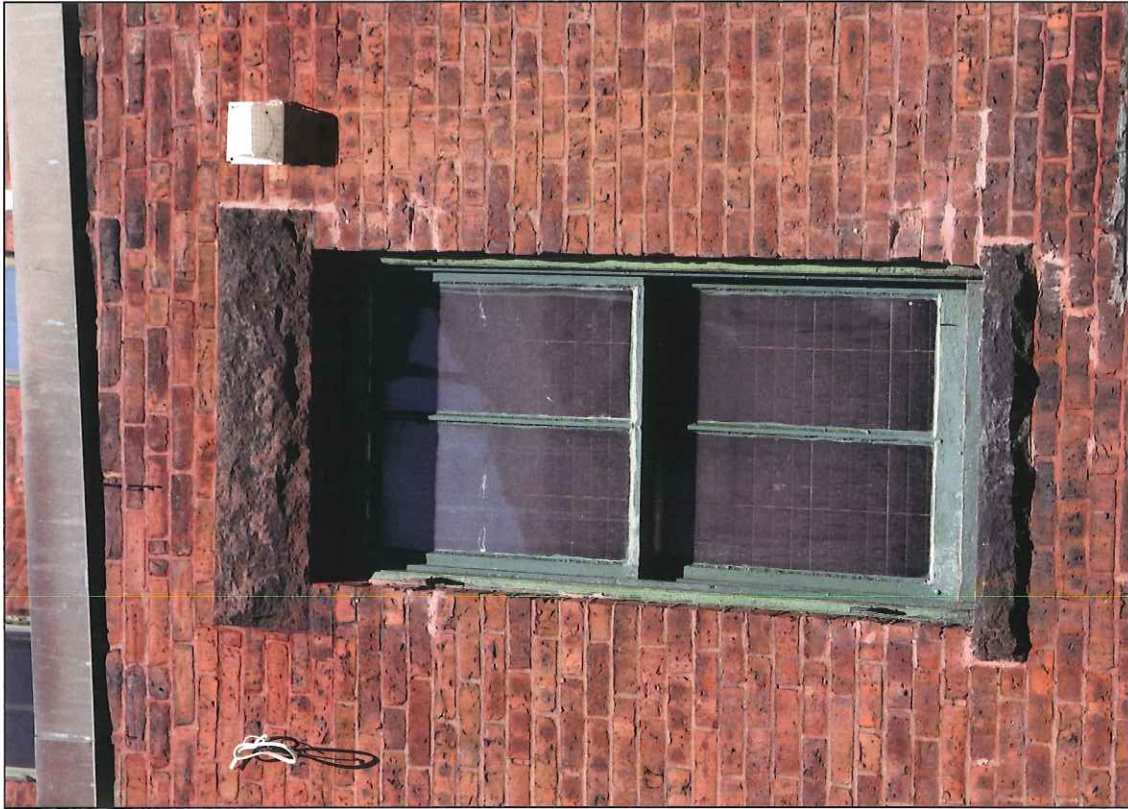

85. South elevation, first floor, window 36



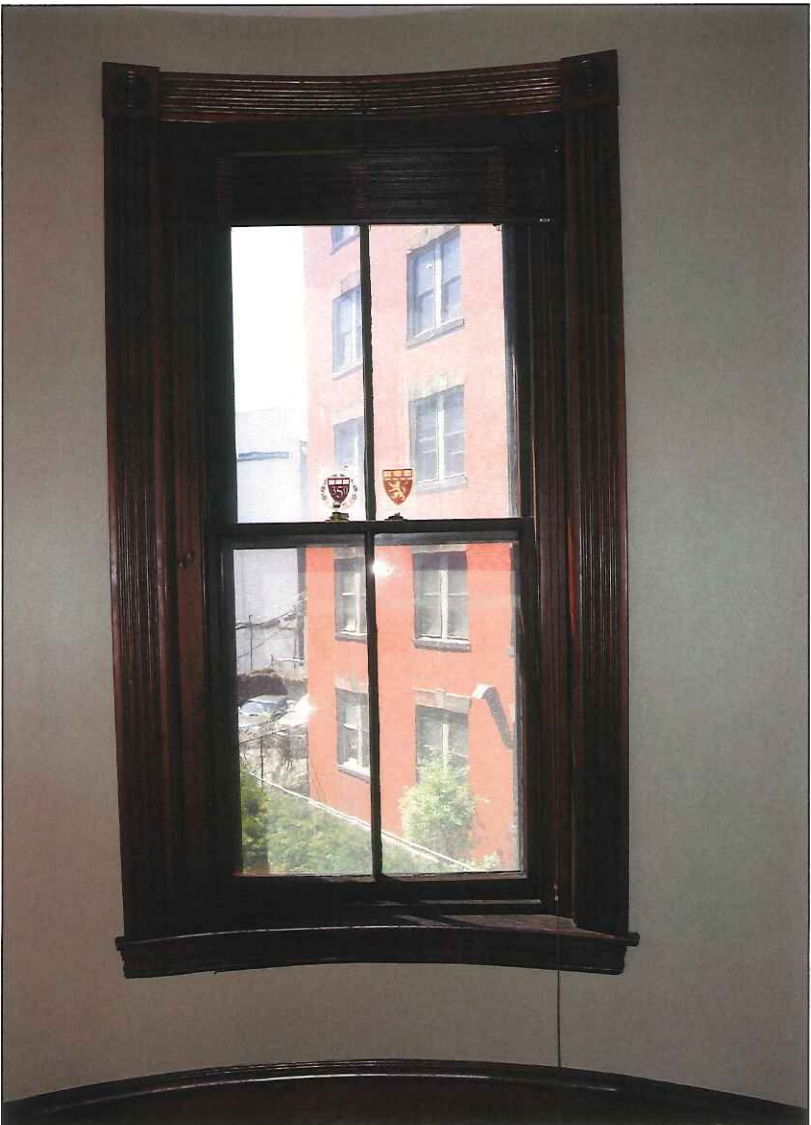

86. South elevation, second floor, window 37

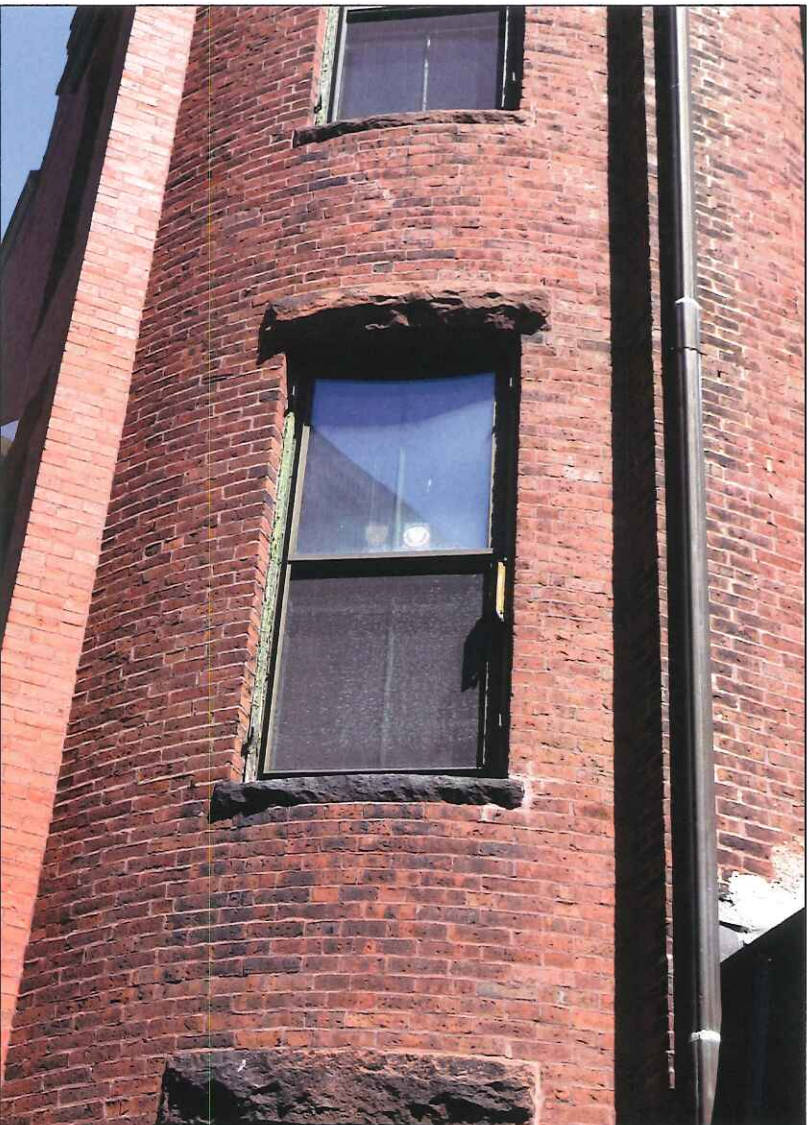

87. South elevation, second floor, window 37







88. South elevation, second floor, window 38

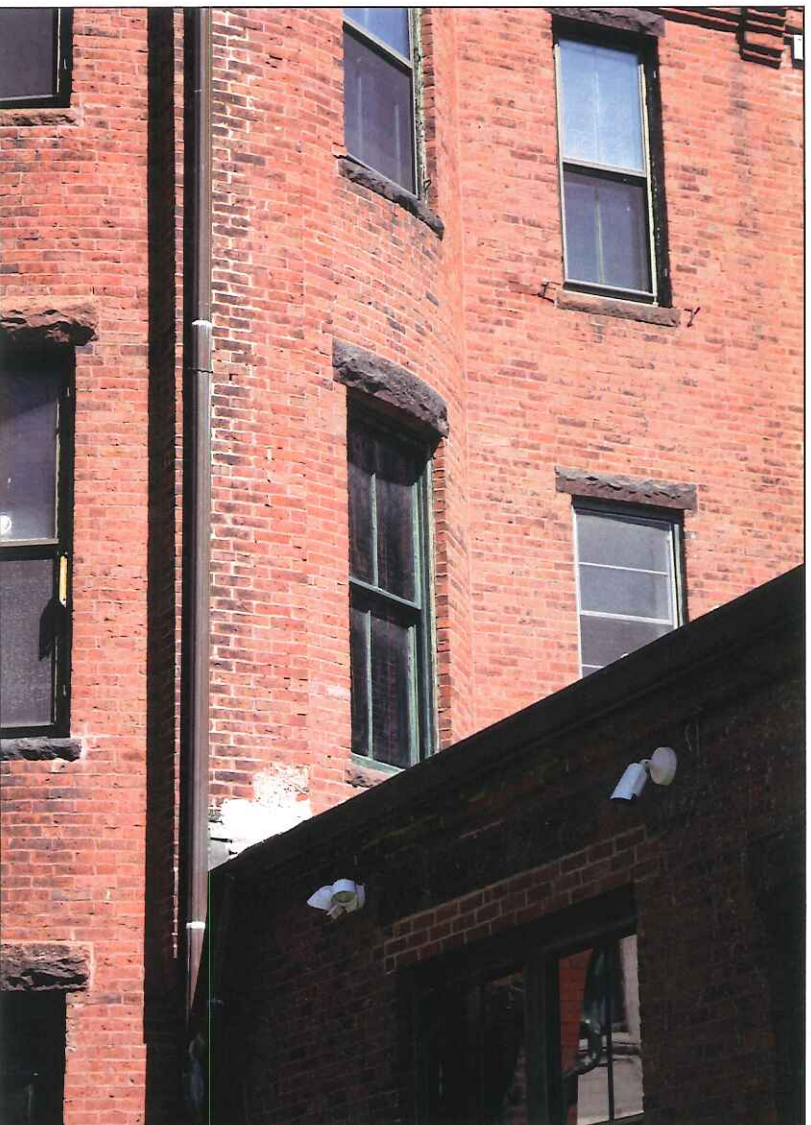

89. South elevation, second floor, window 38







90. South elevation, second floor, window 39

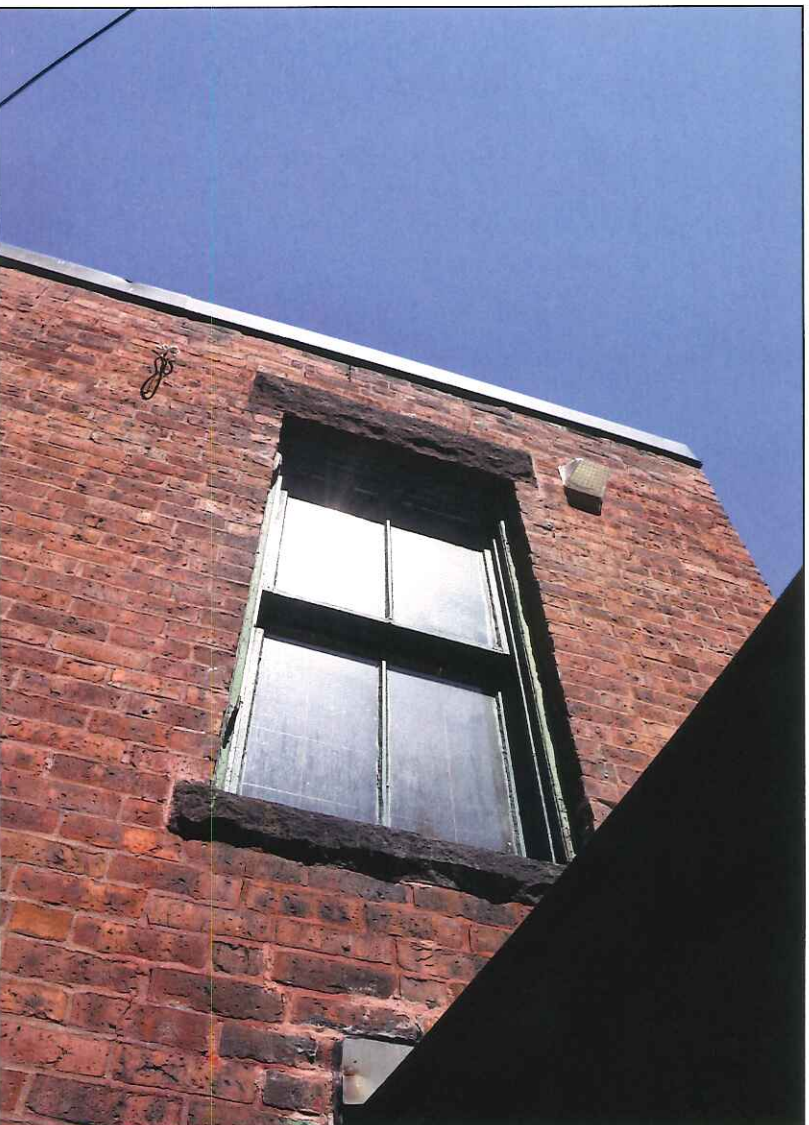

91. South elevation, second floor, window 39





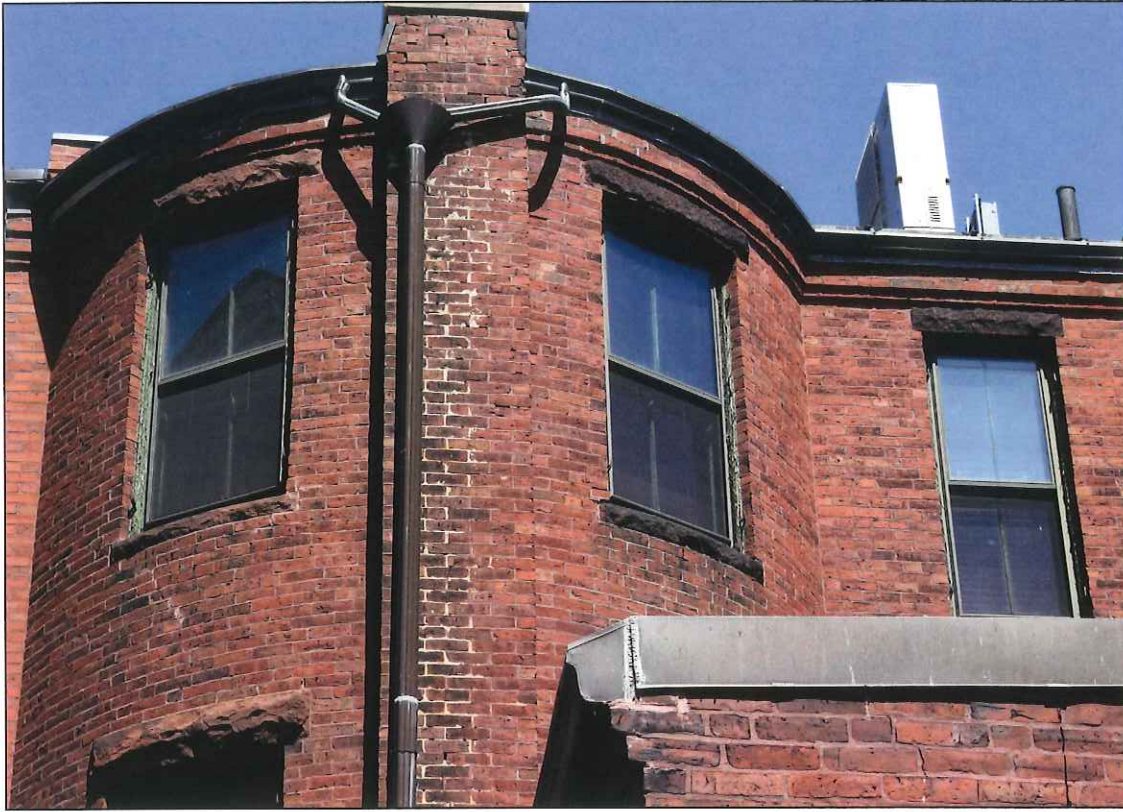

92. South elevation, third floor, windows 40-42



93. South elevation, third floor, window 40



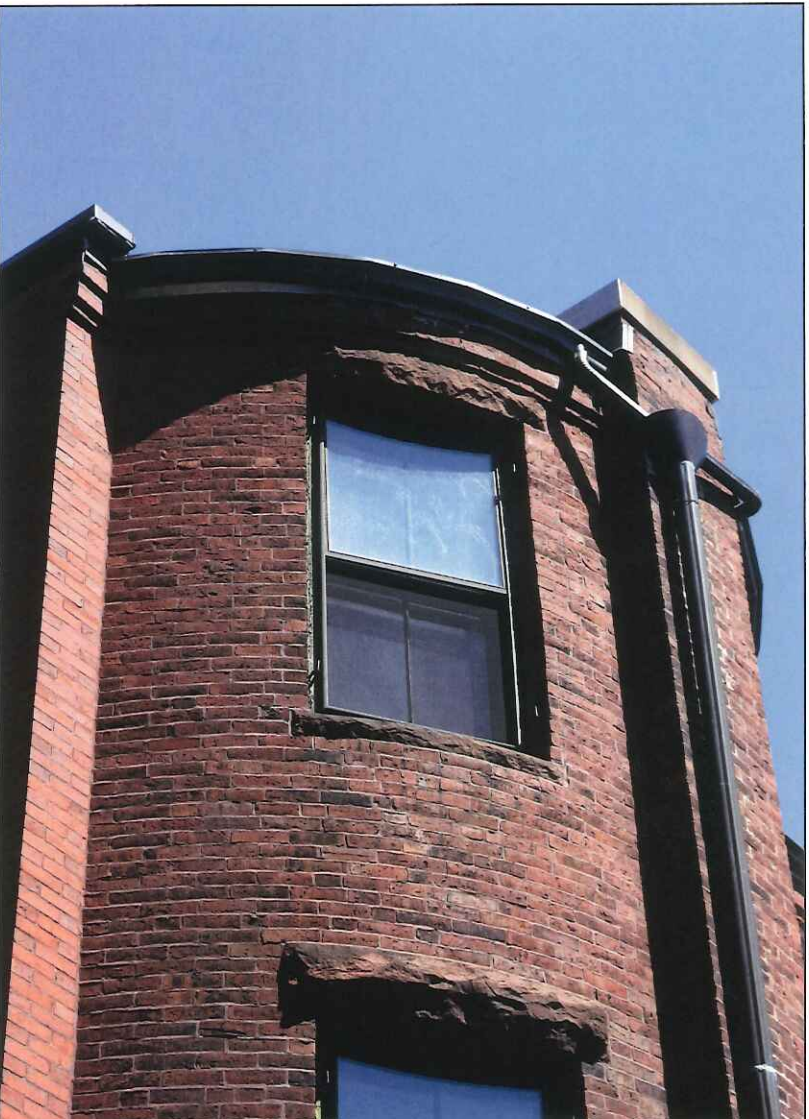

94. South elevation, third floor, window 40



95. South elevation, third floor, window 41





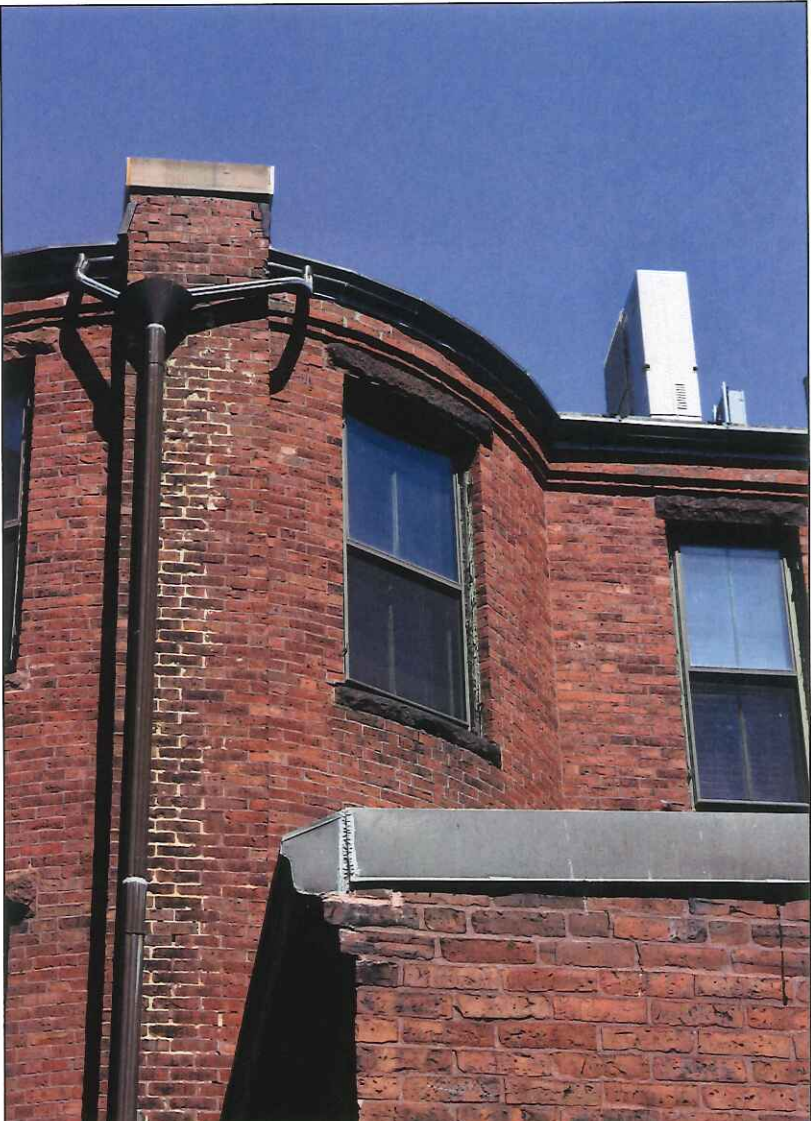

96. South elevation, third floor, window 41



97. South elevation, third floor, window 42



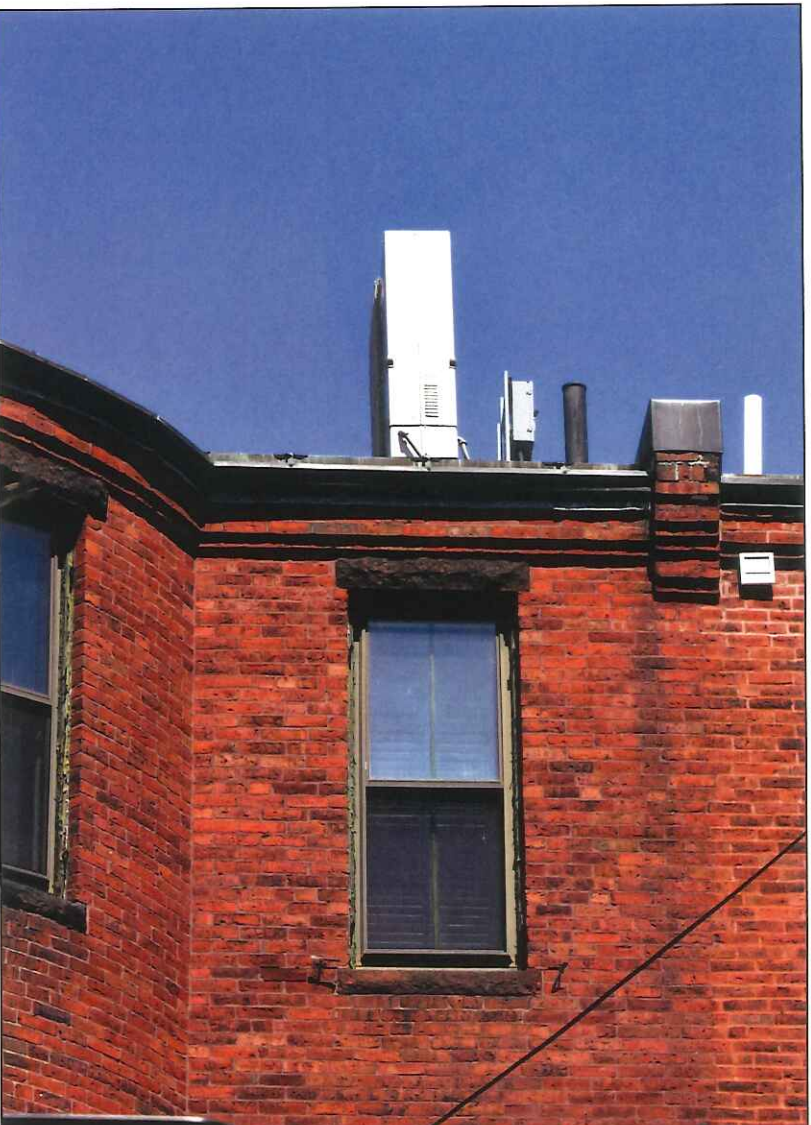

98. South elevation, third floor, window 42

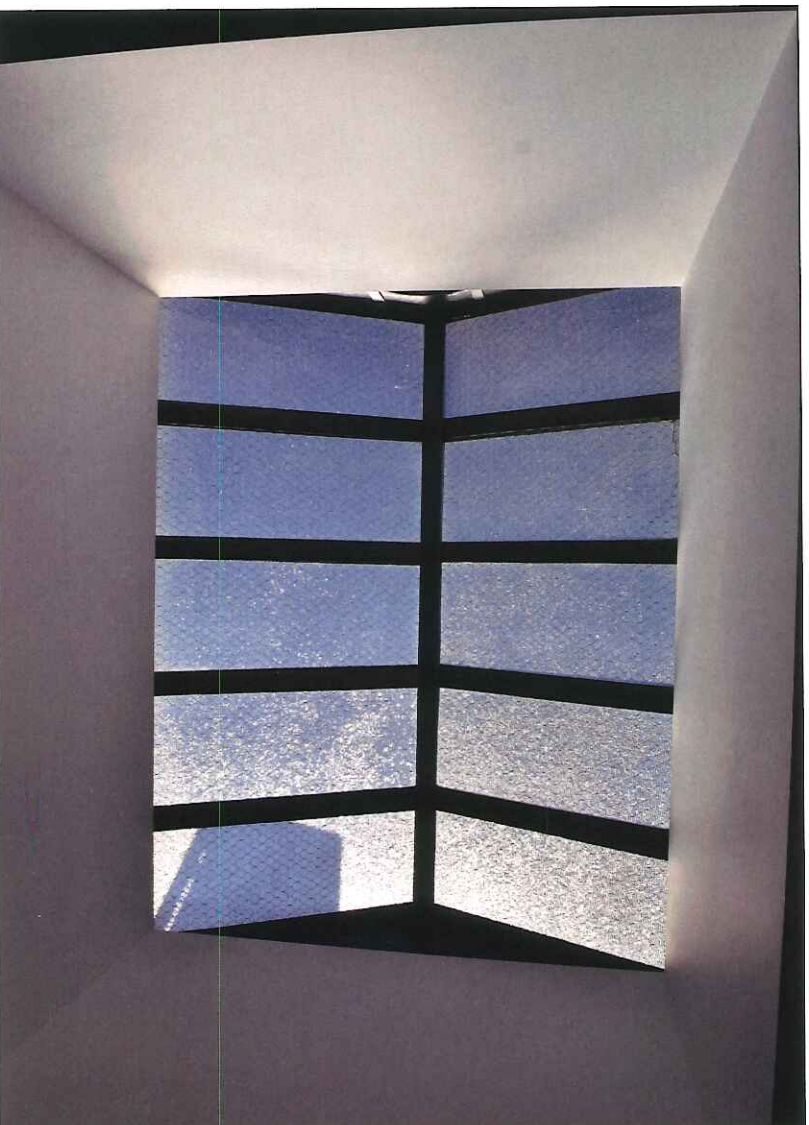

99. Third floor skylight

