

85 West Newton Street, Boston

Schematic Lighting Presentation

Sladen Feinstein Integrated Lighting

DHK Architects

May 7, 2018

NORTH AND WEST ELEVATIONS



SOUTH (GALLERY) AND EAST ELEVATIONS



SOUTH ELEVATION





AGI RENDERINGS/ LIGHTING ANALYSIS

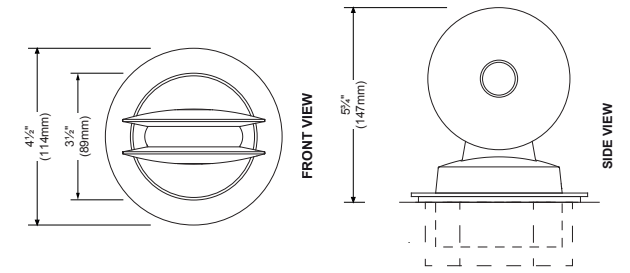
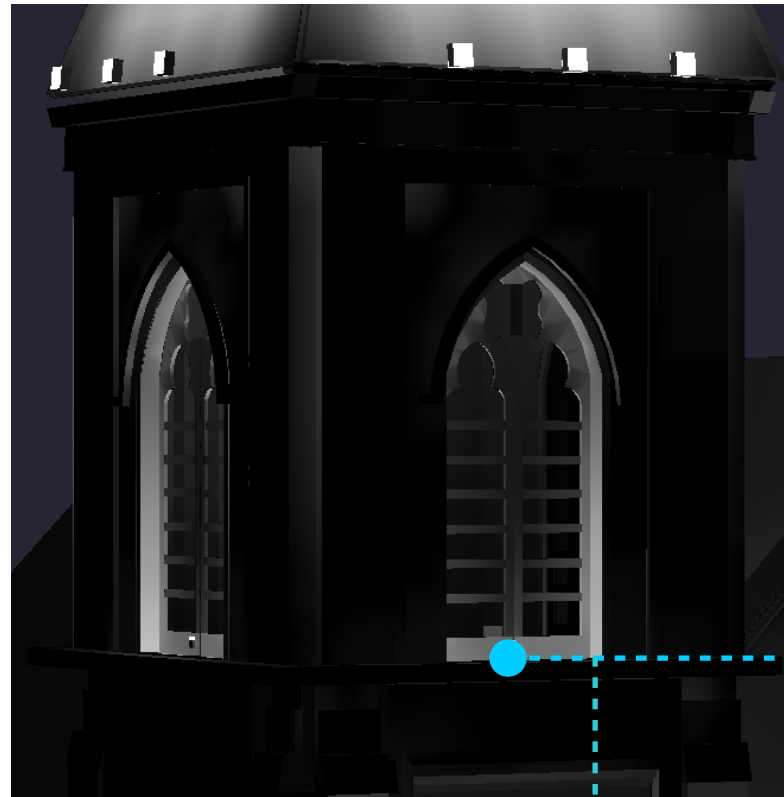

SURFACE MOUNT LED TO LIGHT THE WINDOW FRAME



APPLICATION SHOTS



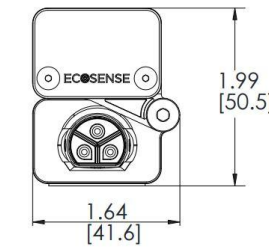
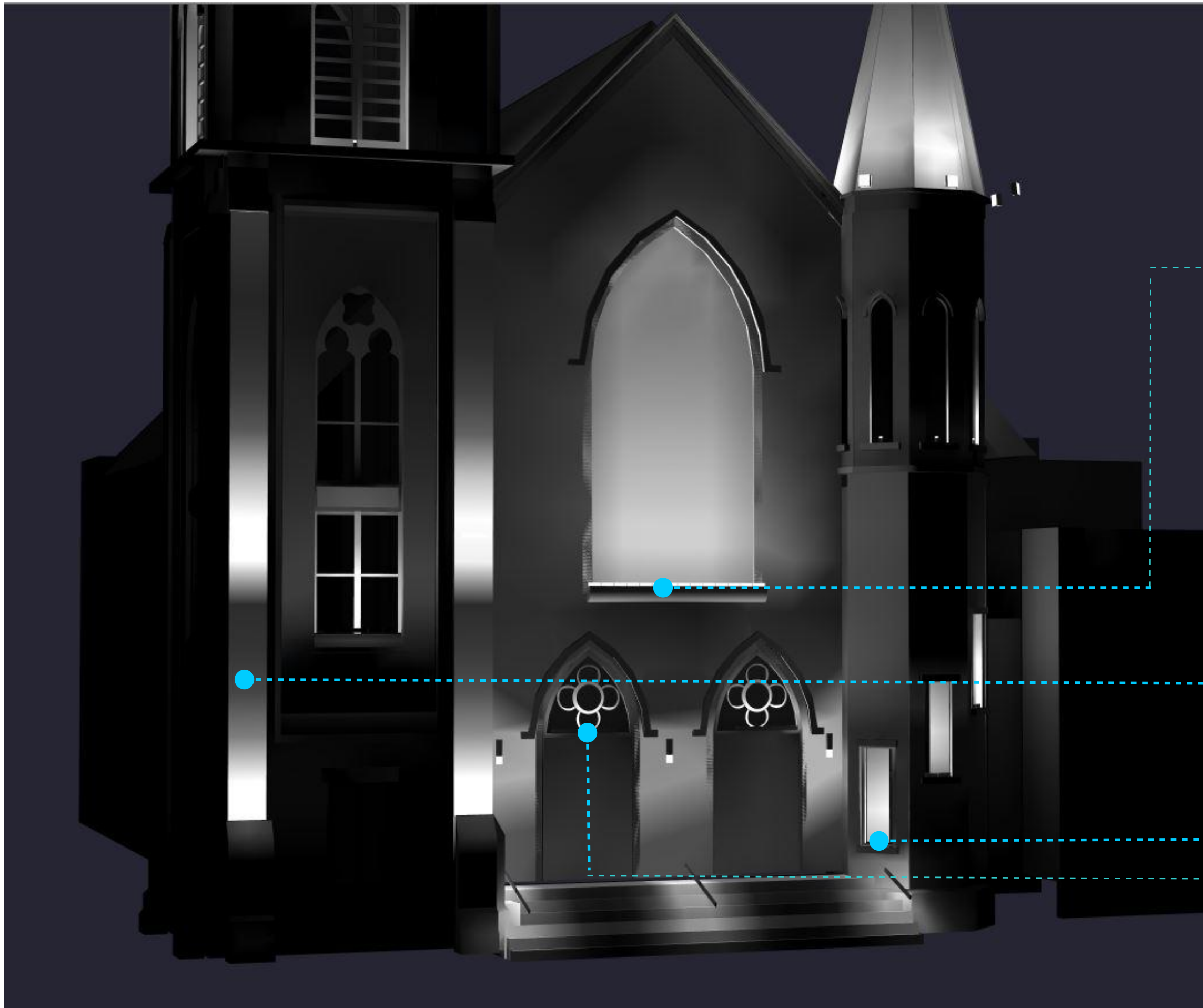

EXTERIOR LINEAR LED WALL GRAZER



EXTERIOR LINEAR LED WALL WASHER



EXTERIOR LINEAR LED WET LOCATION TAPE

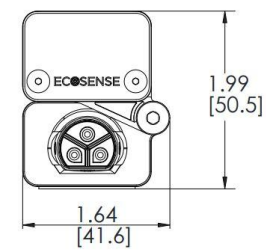
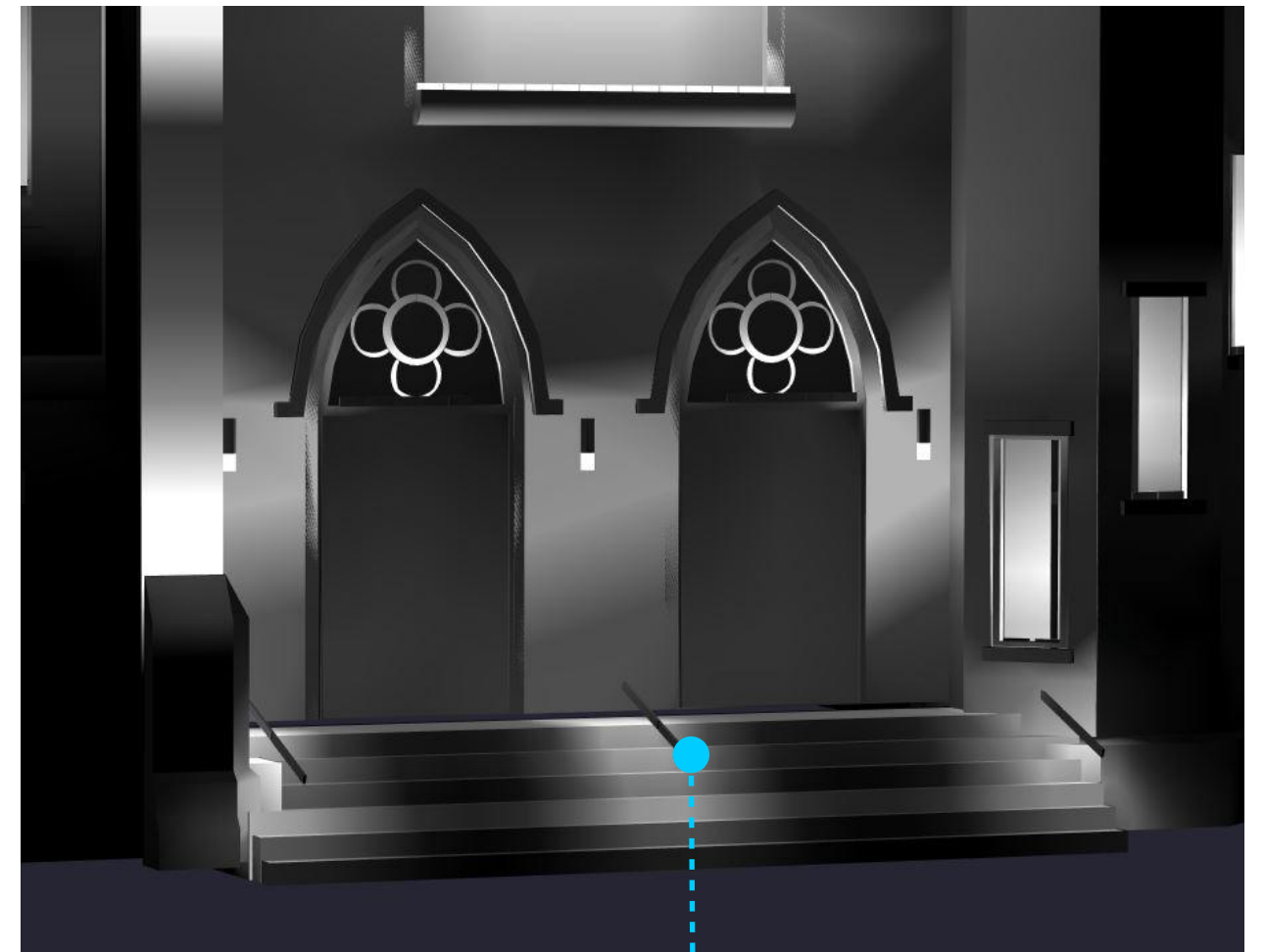
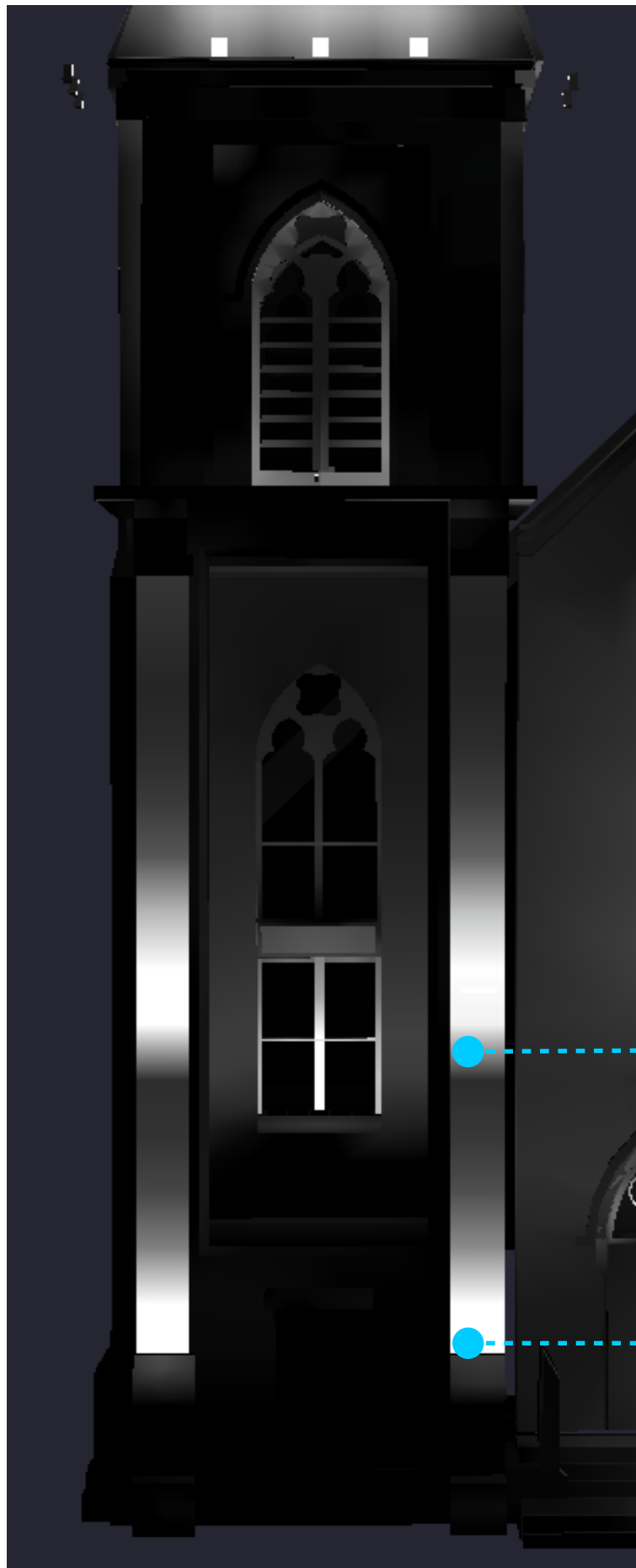

EXTERIOR LINEAR LED WALL GRAZER TO LIGHT COLUMNS

ILLUMINATED HANDRAIL AT THE ENTRANCE

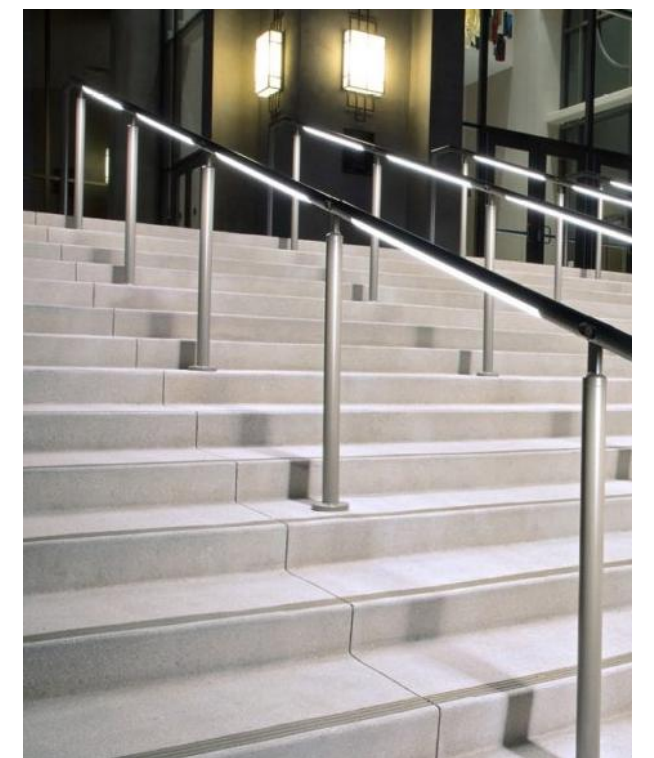

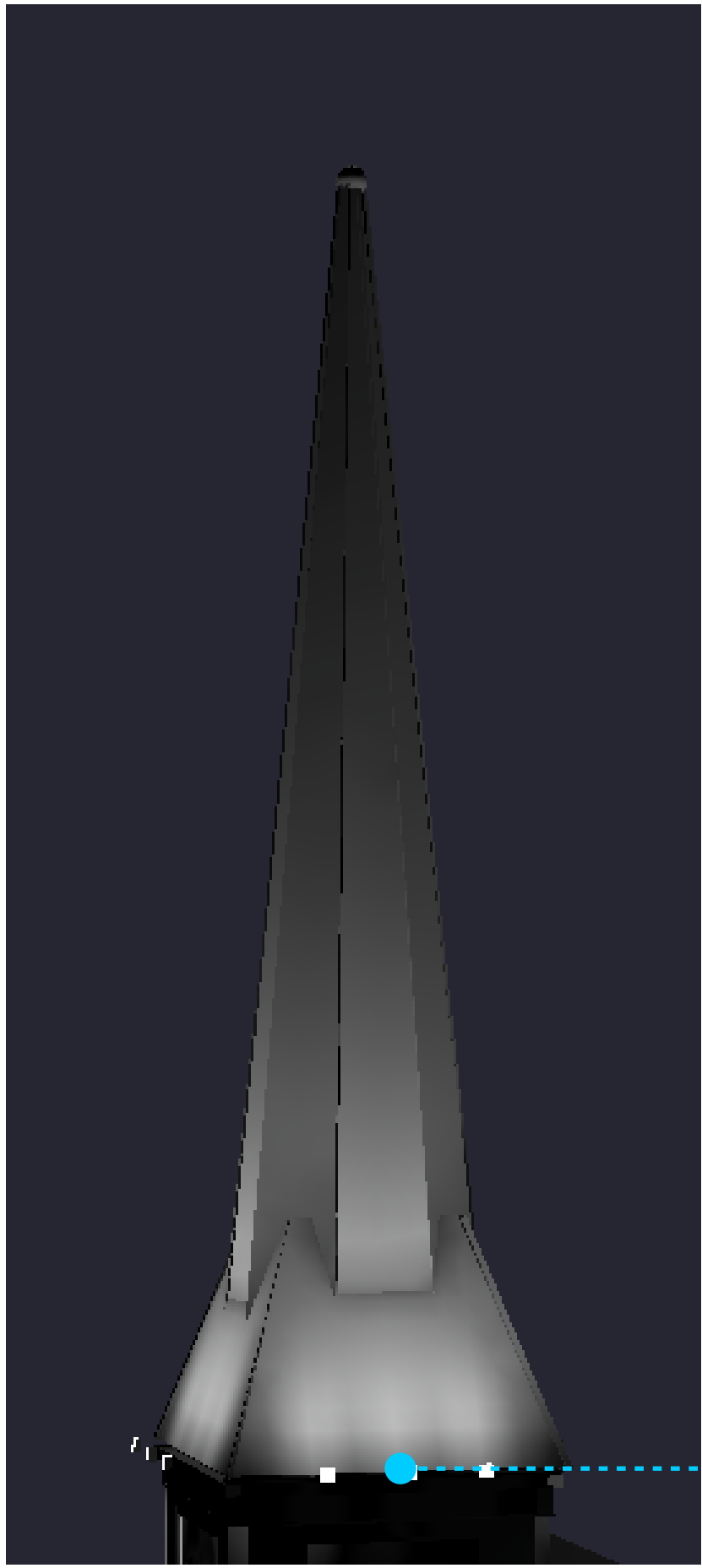

EXTERIOR LINEAR LED FLOOD LIGHT WALL MOUNT

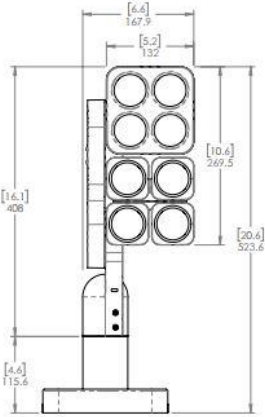

SCONCE OPTIONS FOR THE MAIN ENTRANCE OF THE CENTER OF THE ARTS

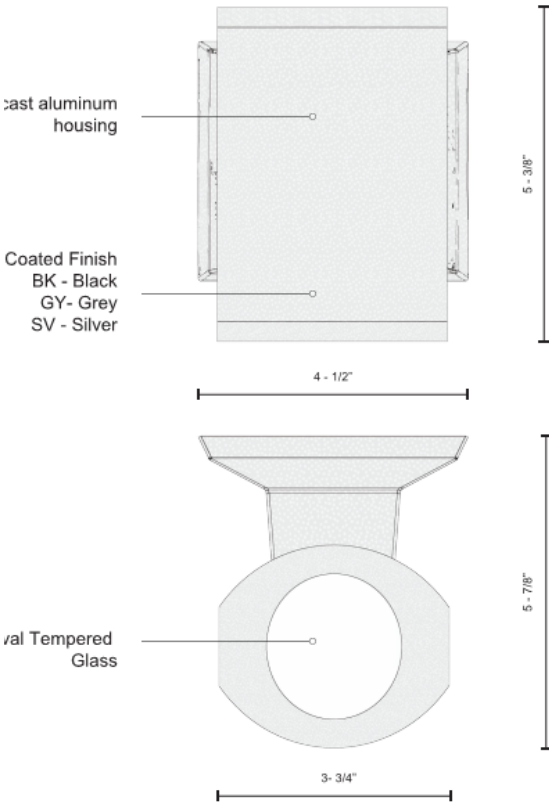

SCONCE OPTIONS FOR THE GALLERY ENTRANCE

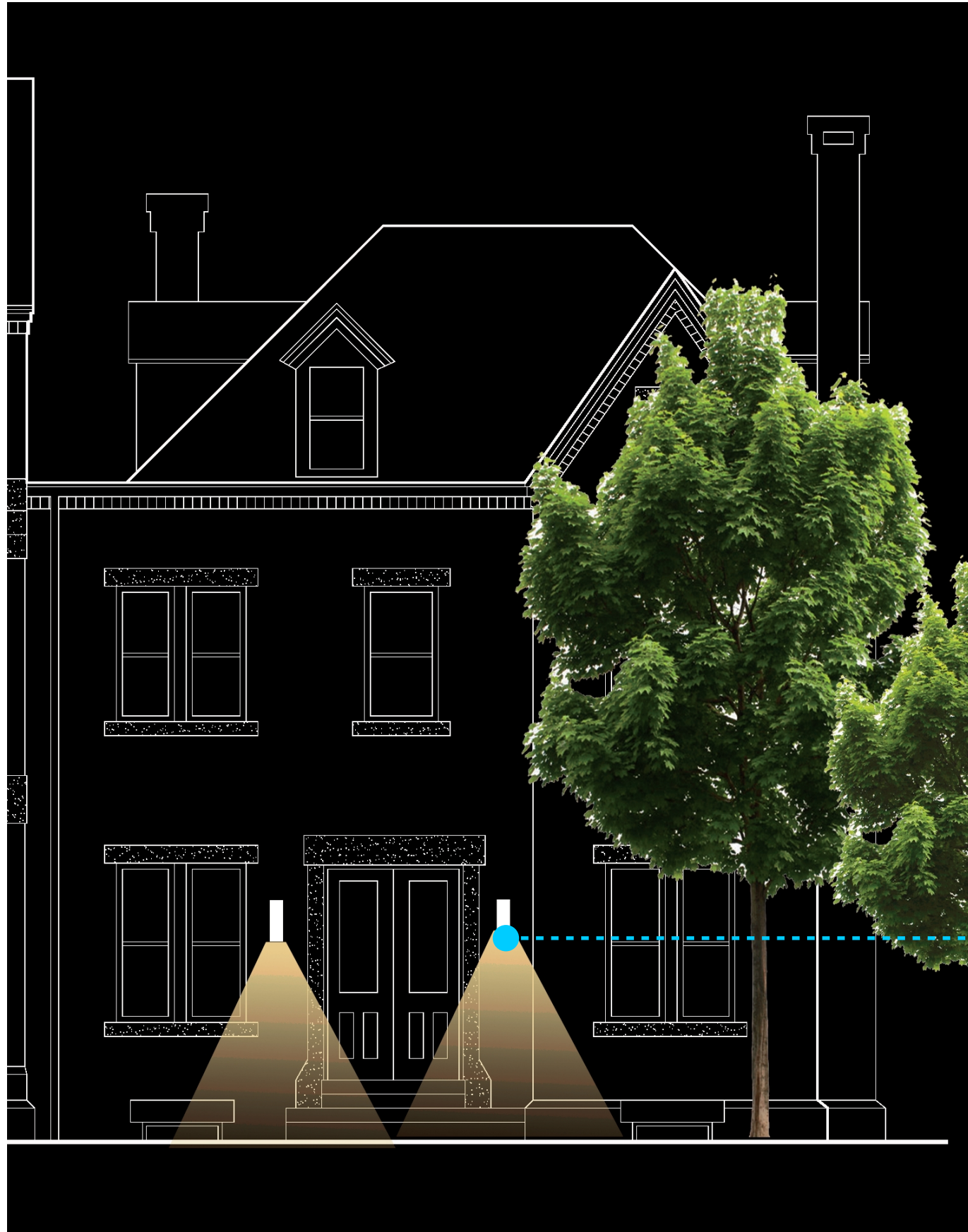

EXTERIOR LED SCONCE AT THE ENTRANCE

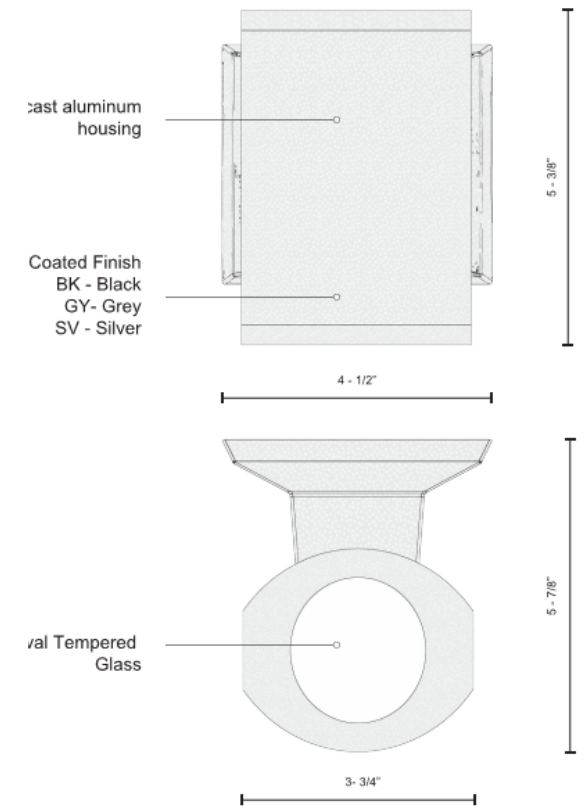

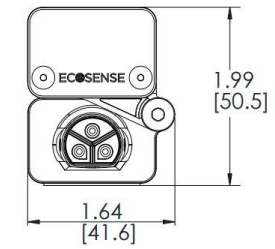

EXTERIOR LINEAR LED WALL GRAZER



EXTERIOR FLOOD LIGHT ABOVE THE DAYCARE ENTRANCE



EXTERIOR DECORATIVE SCENCE ABOVE THE PRESCHOOL ENTRANCE

PATHWAY LIGHTING TO DAYCARE



EXTERIOR LED WEDGE SCNCE



EXTERIOR FLOOD LIGHT ABOVE THE SIGNAGE

Villa Victoria Center for the Arts
85 West Newton Street, Boston

Schematic Signage Presentation to the
South End Landmark District Commission

DHK Architects
May 7, 2018

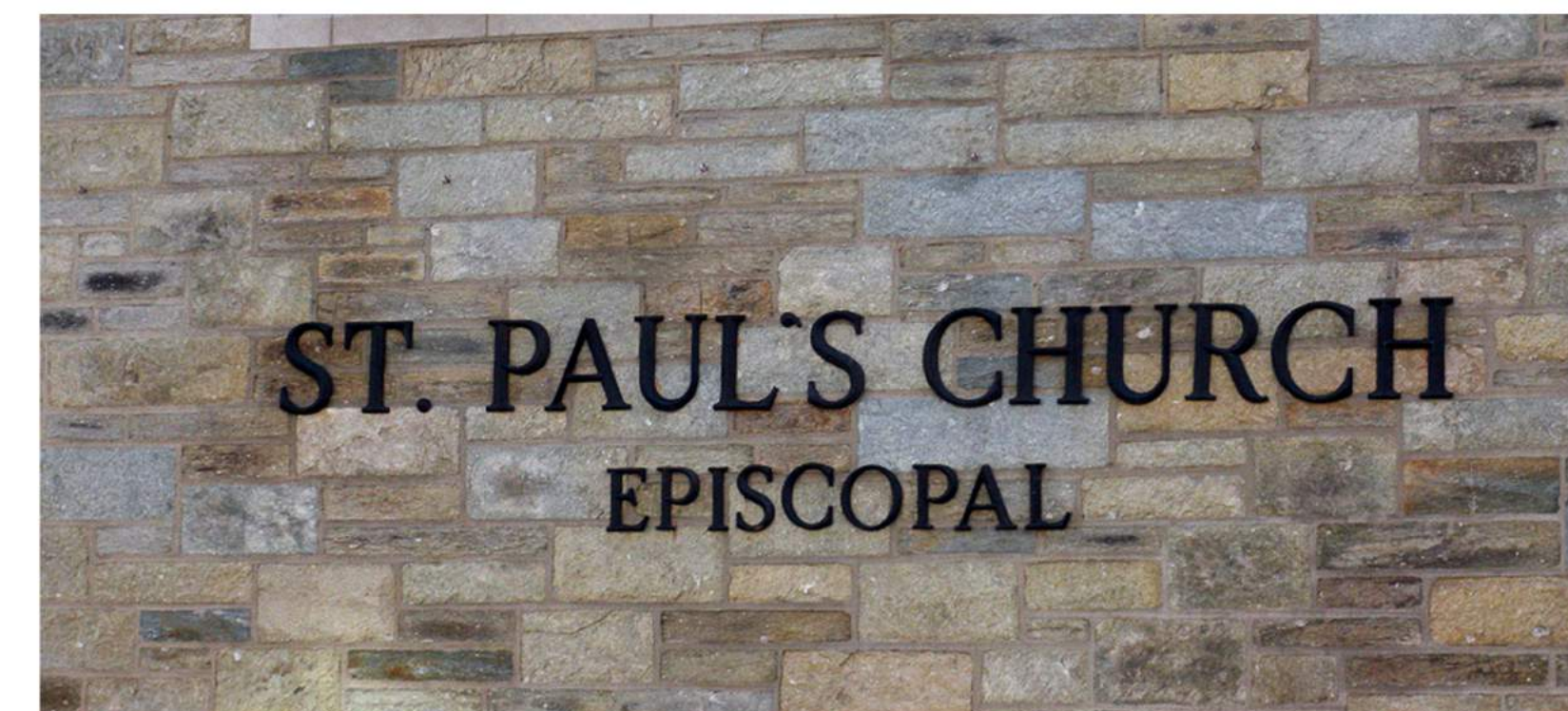

PRECEDENT (CAST BRONZE LETTERS)

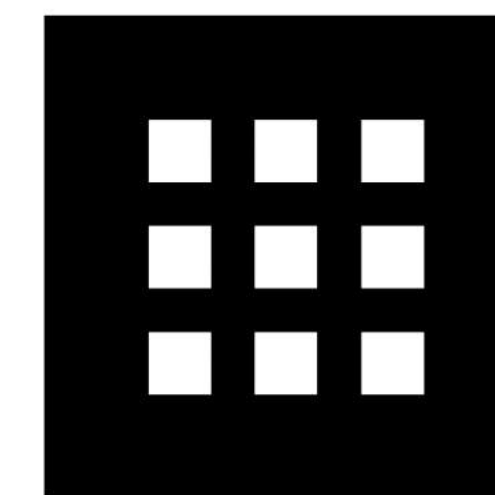

DHK

ARCHITECTS

54 Canal Street
2nd Floor
Boston, MA 02114
617-267-6408
Fax 617-267-1990

PROPOSED EXTERIOR
BUILDING SIGNAGE

Project:
**Villa Victoria
Center for the Arts**
85 WEST NEWTON STREET
BOSTON, MA

WEST ELEVATION

Title	
Scale	
File	
Drawn	
Checked	Drawing
Job	
Date	5/4/18

A1



PRECEDENTS

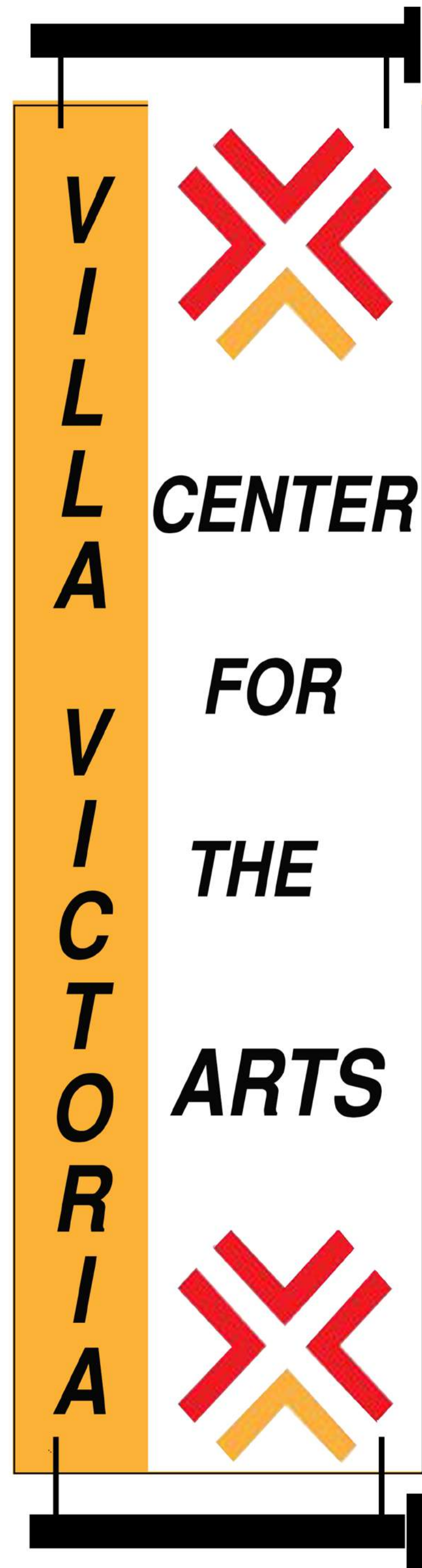

PROPOSED BANNER ("SUNBRELLA")

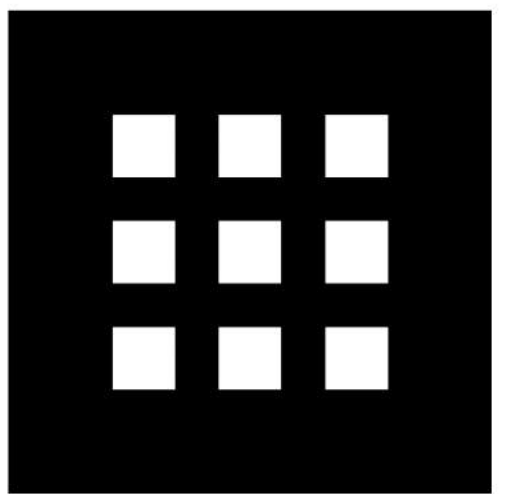

DHK

ARCHITECTS

54 Canal Street
 2nd Floor
 Boston, MA 02114
 617-267-6408
 Fax 617-267-1990

PROPOSED EXTERIOR BUILDING SIGNAGE

Project:
**Villa Victoria
 Center for the Arts**
 85 WEST NEWTON STREET
 BOSTON, MA

Title		
Scale	A2	
File		
Drawn		
Checked		Drawing
Job		
Date	5/4/18	



PROPOSED METAL SIGN

PRECEDENTS

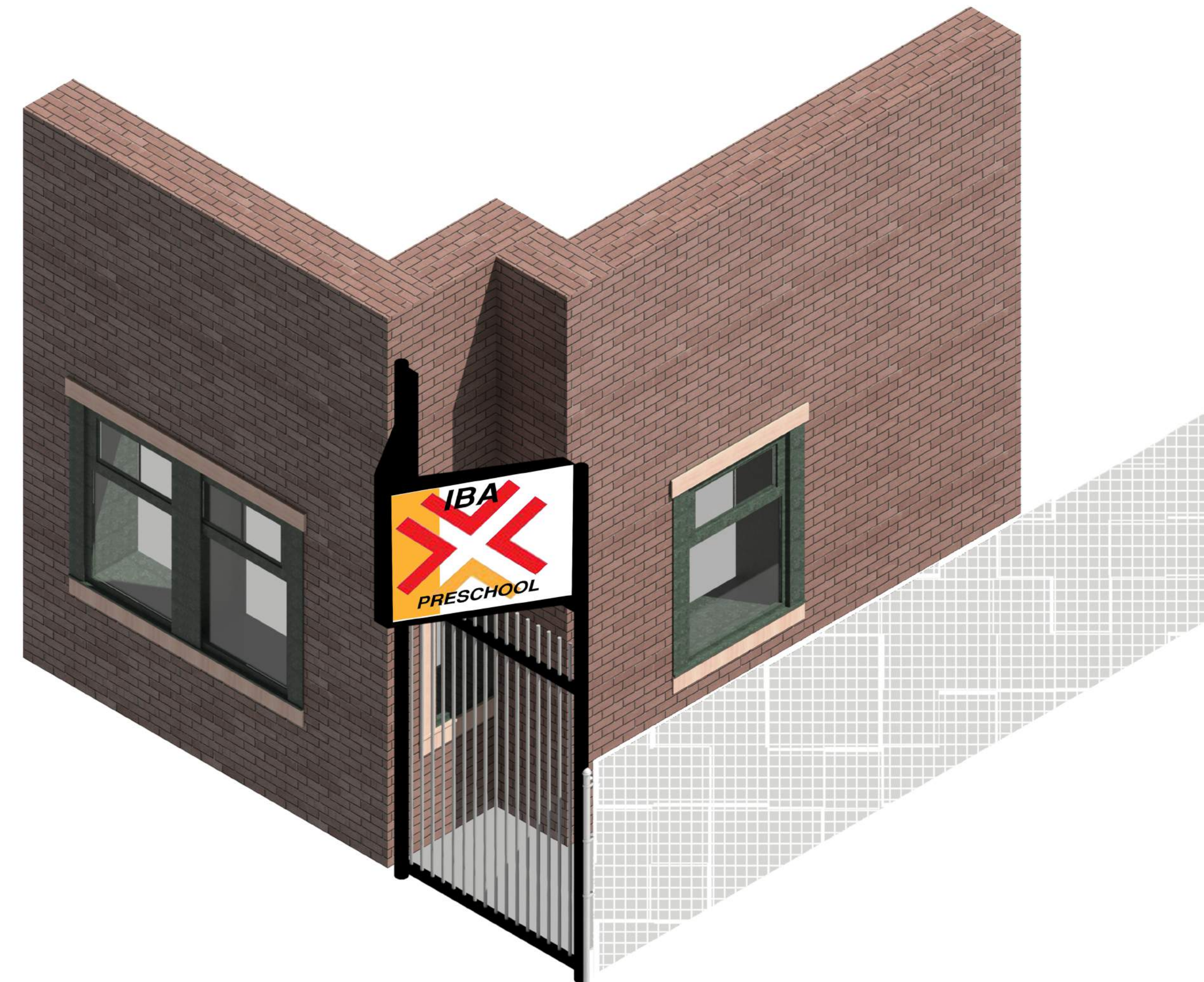

AXON

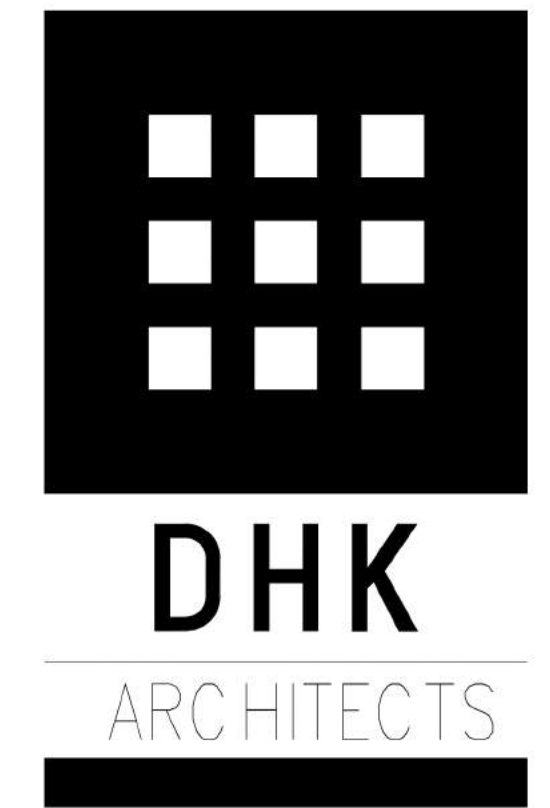

DHK
ARCHITECTS

54 Canal Street
2nd Floor
Boston, MA 02114
617-267-6408
Fax 617-267-1990

PROPOSED EXTERIOR BUILDING SIGNAGE

Project:
**Villa Victoria
Center for the Arts**
85 WEST NEWTON STREET
BOSTON, MA

Title		
Scale	A3	
File		
Drawn		
Checked		Drawing
Job		
Date	5/4/18	